

POSTAL[®]



katalog 08/09



stalowe



POSTAL

katalog 08/09

Ogrodzenie, balustrady, kraty – to elementy, które kształtują wygląd naszego domu. Chronią nas przed intruzami, oddzielają od sąsiadów, a przede wszystkim pełnią funkcję estetyczną i reprezentacyjną. Aby dobrze komponować się z architekturą mogą być proste, geometryczne lub skomplikowane, bogato zdobione.

elementy kute naturalnie...



POSTAL stalowe

Firma Postal od roku 1992 oferuje niezwykle różnorodną i oryginalną gamę elementów do konstruowania kompozycji z metalu. Korzystając z nich można tworzyć niebanalne rozwiązania do wykorzystania w każdym domu. Aby ułatwić Państwu zadanie przygotowaliśmy i wciąż rozwijamy bogaty zbiór gotowych projektów.

Jedno z najważniejszych wyzwań naszej firmy to najwyższa jakość produktów za atrakcyjną cenę. W naszej ofercie znajduje się ponad 10.000 elementów prezentujących najnowocześniejsze trendy.

Zaopatrujemy firmy na terenie całego kraju, jak również poza jego granicami. Zapraszamy do kontaktów z naszą siecią sprzedaży.





elementy kute naturalnie...

Since 1992 Postal has been offering diverse and original items to make metal compositions. With these compositions, you may create one-of-a-kind solutions for every home. To make your choice easier, we offer a number of ready-to-use projects. To offer reasonably priced, top quality products is one of our ambitious challenges we want to meet. The company's offer contains more than 10.000 trendy items.

We supply companies throughout Poland and also abroad.

You are kindly invited to contact our sales network.

Die Firma Postal bietet seit 1992 ein sehr umfangreiches und originelles Sortiment von Elementen und Accessoires aus Metall an. Mit deren Hilfe kann man nicht banale Lösungen erstellen, die in jedem Haushalt verwendet werden können. Um Ihnen die Aufgabe leichter zu machen, haben wir ein umfangreiches Paket von fertigen Projekten vorbereitet, das von uns ständig erweitert wird.

Eine der größten Herausforderungen unserer Firma ist die höchste Qualität zu einem attraktiven Preis. Unser Angebot umfasst über 10.000 Elemente, die den modernsten Trends entsprechen. Wir beliefern die Firmen landesweit als auch außerhalb der Landesgrenzen. Für weitere Kontakte steht Ihnen unser Vertriebsnetz zur Verfügung.

Компания „Postal“ с 1992 г. предлагает необычайно разнообразный и оригинальный ассортимент элементов для составления композиций из металла. С их помощью можно создать небанальные проекты для любого дома. Чтобы упростить Вам задачу, мы подготовили и постоянно развиваем богатую коллекцию готовых проектов.

Одна из наиважнейших задач нашей компании – это наивысшее качество продуктов по привлекательным ценам. В нашем ассортименте свыше 10.000 элементов, представляющих самые современные тренды.

Снабжаем компании по всей стране, а также за ее пределами. Предлагаем связаться с нашей сетью продаж.



POSTAL ponad

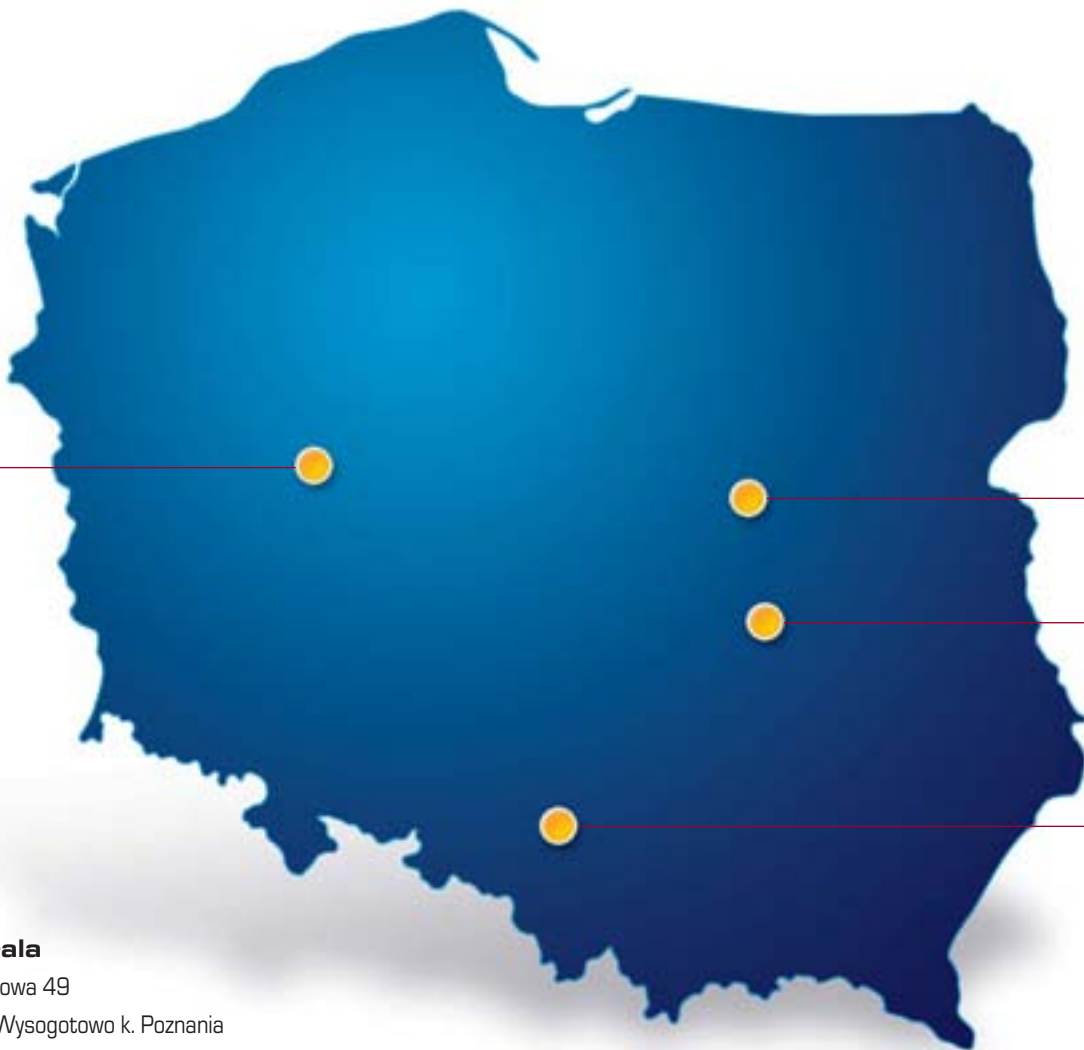

Centrala

ul. Olszynowa 49

62-081 Wysogotowo k. Poznania

tel. 048 61 65 25 900

fax 048 61 65 25 910

e-mail: biuro@postal.pl



10.000 elementów



• Oddział Warszawa

ul. Al. Krakowska 12
05-090 Janki/Warszawa
tel. 022 715 65 15
fax 022 720 12 72
e-mail: biuro@postal.pl



• Oddział Radom

ul. Chorzowska 14
26-600 Radom
tel. 048 36 51 272
fax 048 36 51 283
e-mail: radom@postal.pl



• Oddział Śląsk

ul. Gliwicka 17
44-178 Przyszowice/k. Gliwic
tel. 032 230 28 42
fax 032 230 28 43



www.postal.pl

spis treści

- | | | | |
|---|--|---|---|
|  | 8 elementy spiralne z płaskownika 12 x 6 mm
scrolls made of a flat bar 12 x 6 mm
Spiralelemente aus Flacheisen 12 x 6 mm
спиральные элементы из полос 12 x 6 мм |  | 29 taśmy
banding materials
Bände
ленты |
|  | 9 elementy spiralne z płaskownika fakturowanego 12 x 6 mm
scrolls made of a textured bar 12 x 6 mm
Spiralelemente aus strukturiertem Flacheisen 12 x 6 mm
спиральные элементы из фактурных полос 12 x 6 мм |  | 30 pręty
bars
Stäbe
прутья |
|  | 10 elementy spiralne z pręta 12 x 12 mm
scrolls made of a bar 12 x 12 mm
Spiralelemente aus Stab 12 x 12 mm
спиральные элементы из прутьев 12 x 12 мм |  | 30 pręty kształtowe i otworowane (do krat)
shaping bars and bars with openings (for gratings)
geformte Stäbe und Lochstäbe (für Fenstergitter)
фасонные прутья и прутья с отверстиями (для решеток) |
|  | 11 koszyki
baskets
Körbe
корзины |  | 31 profile zamknięte – kwadratowe fakturowane
closed sections – square, textured
Stäbe
прутья |
|  | 12 rozety
rosettes
Rosetten
розетки |  | 31 profile zamknięte – prostokątne fakturowane
closed sections – rectangular, textured
geschlossene Profile – quadratisch, strukturiert
замкнутые профили – квадратные фактурные |
|  | 18 tralki kształtowe
shaped balusters
geformte Stäbe
фасонные балясины |  | 32 groty, szpice, zwieńczenia
spears, points, tops
Pfahlspitzen, Spitzen, Verzierungen
замкнутые профили – прямоугольные фактурные |
|  | 19 tralki gładkie
plain balusters
glatte Stäbe
гладкие балясины |  | 35 przekuwki, nasadki
slugs, caps
Rohrteile, Aufsätze
кованые элементы, насадки |
|  | 21 tralki rurowe
tubular balusters
Rohrstäbe
трубчатые балясины |  | 36 gałki
knobs
Knöpfe
набалдашники |
|  | 21 tralki fakturowane
textured balusters
Strukturierte Stäbe
фактурные балясины |  | 36 kule pełne, gładkie
plain full spheres
volle, glatte Kugeln
шары сплошные гладкие |
|  | 22 tralki kute
forged balusters
Schmiedestäbe
кованые балясины |  | 37 kule pełne, fakturowane
textured full spheres
volle, strukturierte Kugeln
шары сплошные фактурные |
|  | 24 słupy balustradowe
baluster posts
Brüstungspfosten
балюстрадные столбы |  | 37 kule puste, gładkie
plain hollow spheres
glatte Hohlkugeln
шары полые гладкие |
|  | 25 płaskowniki, poręcze
flat bars, railings
Flachstangen, Geländer
полосы, поручни |  | 37 maskownice, szyldy maskujące
masking frames, escutcheons
Blenden, Blendschilder
маскировочные элементы |

- | | | | |
|---|---|---|---|
|  | 39 kwiaty, liście i motywy roślinne
flowers, leaves, flower ornaments
Blumen, Blätter, Ornamente mit Pflanzmotiven
цветы, листья, растительные орнаменты |  | 71 wkładki
lock inserts
Schlosskästen
вкладыши |
|  | 49 zespoły ozdobne – staliwo
ornamental sets – cast steel
Dekorgruppen – Stahlguss
декоративные системы – литая сталь |  | 71 mocowania
fixings
Aufnahmen
крепления |
|  | 53 żeliwa
cast iron items
Gusseisen Waren
чугунные элементы |  | 71 nity
rivets
Niete
заклепки |
|  | 55 wózki i akcesoria
cantilever gate carriages, accessories
Wagen, Zubehör
каретки, аксессуары |  | 72 łańcuchy ozdobne
decorative chains
Zierketten
декоративные цепи |
|  | 56 listwy
strips
Leisten
планки |  | 72 zasuw i rygle
bolts and locks
Schieber und Riegel
щеколды и засовы |
|  | 56 rolki
rolls
Rollen
ролики |  | 73 cyfry i litery
digits and letters
Buchstaben und Zahlzeichen
цифры и буквы |
|  | 56 zawiasy
hinges
Scharniere
петли |  | 74 wskaźniki wiatru
weathervanes
Wetterfahnen
флюгера |
|  | 60 daszki
post tops
Deckel
навесы |  | 74 skrzynki pocztowe
letter boxes
Briefkästen
почтовые ящики |
|  | 61 zaślepki
stoppers
Verschlusskappen
заглушки |  | 75 lampy
lamps
Lampen
лампа |
|  | 62 maskownice do śrub
screw caps
Blenden für Schrauben
маскировочные элементы для болтов |  | 76 zestawy kominkowe
fireplace sets
Kaminsätze
каминные системы |
|  | 62 klamki kute
forged door handles
geschmiedete Griffe
кованые ручки |  | 77 farby
paints
Farben
краски |
|  | 64 szyldy (otwory w rozstawie 90 mm)
escutcheons (spacing of openings – 90 mm)
Schilder (Abstand zwischen den Öffnungen 90 mm)
накладки (отверстия с шагом 90 мм) |  | 77 patyny
patina paints
Edelrost
патины |
|  | 68 zamki
locks
Türschlösser
замки |  | 78 automatyka bram
gate automation systems
Torautomatik
автоматика для ворот |

elementy spiralne z płaskownika 12 x 6 mm

scrolls made of a flat bar 12 x 6 mm / Spiralelemente aus Flacheisen 12 x 6 mm / спиральные элементы из полос 12 x 6 мм



NOWOŚĆ

nr kat. **10.002**
□ (mm) 12 x 6
H (mm) 95
L (mm) 60



NOWOŚĆ

nr kat. **10.006**
□ (mm) 12 x 6
H (mm) 120
L (mm) 70



NOWOŚĆ

nr kat. **10.009**
□ (mm) 12 x 6
H (mm) 150
L (mm) 75



NOWOŚĆ

nr kat. **10.013**
□ (mm) 12 x 6
H (mm) 150
L (mm) 70



NOWOŚĆ

nr kat. **10.020**
□ (mm) 12 x 6
H (mm) 120
L (mm) 80



NOWOŚĆ

nr kat. **10.030**
□ (mm) 12 x 6
H (mm) 250
L (mm) 75

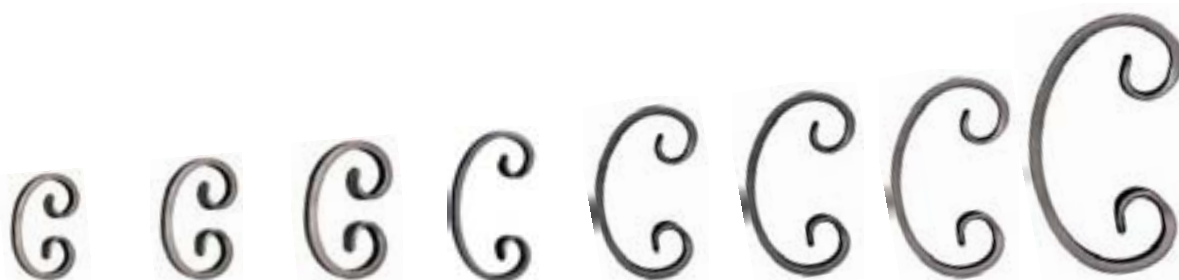

nr kat. **10.091**
□ (mm) 12 x 6
H (mm) 80
L (mm) 50

nr kat. **10.092**
□ (mm) 12 x 6
H (mm) 95
L (mm) 60

nr kat. **10.094**
□ (mm) 12 x 6
H (mm) 115
L (mm) 75

nr kat. **10.095**
□ (mm) 12 x 6
H (mm) 120
L (mm) 70

nr kat. **10.096**
□ (mm) 12 x 6
H (mm) 130
L (mm) 70

nr kat. **10.097**
□ (mm) 12 x 6
H (mm) 150
L (mm) 75

nr kat. **10.098**
□ (mm) 12 x 6
H (mm) 160
L (mm) 80

nr kat. **10.099**
□ (mm) 12 x 6
H (mm) 220
L (mm) 120



nr kat. **10.100**
□ (mm) 12 x 6
H (mm) 150
L (mm) 70

nr kat. **10.100.01**
□ (mm) 12 x 6
H (mm) 170
L (mm) 80

nr kat. **10.100.02**
□ (mm) 12 x 6
H (mm) 195
L (mm) 90

nr kat. **10.101**
□ (mm) 12 x 6
H (mm) 230
L (mm) 115

nr kat. **10.102**
□ (mm) 12 x 6
H (mm) 260
L (mm) 115

nr kat. **10.105**
□ (mm) 12 x 6
H (mm) 250
L (mm) 75



nr kat. **10.107**
□ (mm) 12 x 6
H (mm) 300
L (mm) 120

nr kat. **10.108**
□ (mm) 12 x 6
H (mm) 330
L (mm) 130





nr kat. **10.109**
□ (mm) 12 x 6
H (mm) 120
L (mm) 80





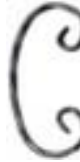

nr kat. **10.110**
□ (mm) 12 x 6
H (mm) 120
L (mm) 60

nr kat. **10.111**
□ (mm) 12 x 6
H (mm) 120
L (mm) 60





elementy spiralne z płaskownika fakturowanego 12 x 6 mm

scrolls made of a textured bar 12 x 6 mm / Spiralelemente aus strukturiertem Flacheisen 12 x 6 mm / спиральные элементы из фактурных полос 12 x 6 мм

						
nr kat.	10.200	10.201	10.202	10.203	10.204	10.205
baza (mm)	12 x 6	12 x 6	12 x 6	12 x 6	12 x 6	12 x 6
H (mm)	80	100	120	130	160	220
L (mm)	50	60	70	75	80	130

						
nr kat.	10.206	10.207	10.208	10.209	10.210	10.211
baza (mm)	12 x 6	12 x 6	12 x 6	12 x 6	12 x 6	12 x 6
H (mm)	150	170	220	270	300	330
L (mm)	65	80	100	110	120	130

					
nr kat.	10.213	10.214	10.215	10.216	10.217
baza (mm)	12 x 6	12 x 6	12 x 6	12 x 6	12 x 6
H (mm)	160	150	120	120	190
L (mm)	50	100	60	60	140

					
nr kat.	10.220	10.221	10.222	10.223	10.224
baza (mm)	12 x 6	12 x 6	12 x 6	12 x 6	12 x 6
H (mm)	260	260	260	340	120
L (mm)	60	75	75	120	100



nr kat. 10.230
baza (mm) 12 x 6
H (mm) 180
L (mm) 90



nr kat. 10.231
baza (mm) 12 x 6
H (mm) 220
L (mm) 120



nr kat. 10.240
baza (mm) 12 x 6
H (mm) 150
L (mm) 100



nr kat. 10.241
baza (mm) 12 x 6
H (mm) 150
L (mm) 100



nr kat. 10.242
baza (mm) 12 x 6
H (mm) 190
L (mm) 140



nr kat. 10.243
baza (mm) 12 x 6
H (mm) 190
L (mm) 140



nr kat. 10.250
baza (mm) 12 x 6
H (mm) 150
L (mm) 100



nr kat. 10.251
baza (mm) 12 x 6
H (mm) 150
L (mm) 100



nr kat. 10.252
baza (mm) 12 x 6
H (mm) 200
L (mm) 130



nr kat. 10.253
baza (mm) 12 x 6
H (mm) 200
L (mm) 130

elementy spiralne z pręta 12 x 12 mm

scrolls made of a bar 12 x 12 mm / Spiralelemente aus Stab 12 x 12 mm / спиральные элементы из прутьев 12 x 12 мм



nr kat. 10.301
baza (mm) □ 12
H (mm) 120
L (mm) 73



nr kat. 10.302
baza (mm) □ 12
H (mm) 130
L (mm) 80



nr kat. 10.303
baza (mm) □ 12
H (mm) 150
L (mm) 82



nr kat. 10.304
baza (mm) □ 12
H (mm) 190
L (mm) 123



nr kat. 10.305
baza (mm) □ 12
H (mm) 220
L (mm) 128



nr kat. 10.310
baza (mm) □ 12
H (mm) 180
L (mm) 88



nr kat. 10.311
baza (mm) □ 12
H (mm) 250
L (mm) 127



nr kat. 10.312
baza (mm) □ 12
H (mm) 260
L (mm) 120



nr kat. 10.320
baza (mm) □ 12
H (mm) 125
L (mm) 65



nr kat. 10.330
baza (mm) □ 12
H (mm) 450
L (mm) 90



nr kat. 10.414
baza (mm) □ 12
H (mm) 150
L (mm) 100



nr kat. **11.031**
baza (mm) 12 x 6
Ø (mm) 100



nr kat. **11.032**
baza (mm) 12 x 6
Ø (mm) 120



nr kat. **11.033**
baza (mm) 12 x 6
Ø (mm) 120



nr kat. **11.232**
baza (mm) 12 x 6
Ø (mm) 120



nr kat. **11.233**
baza (mm) 12 x 6
Ø (mm) 120



nr kat. **11.234**
baza (mm) 12 x 6
H (mm) 190
L (mm) 115



nr kat. **11.250**
baza (mm) 12 x 6
H (mm) 230
L (mm) 120



nr kat. **11.252**
baza (mm) 12 x 6
H (mm) 300
L (mm) 115



nr kat. **11.331**
baza (mm) 12 x 12
Ø (mm) 100



nr kat. **11.332**
baza (mm) 12 x 12
Ø (mm) 120

koszyki

baskets / Körbe / корзины



nr kat. **12.010**
baza (mm) □ 6
H (mm) 70
L (mm) 70



nr kat. **12.080**
baza (mm) □ 12
H (mm) 130
L (mm) 60



nr kat. **12.081**
baza (mm) □ 14
H (mm) 130
L (mm) 65



nr kat. **12.082**
baza (mm) □ 16
H (mm) 145
L (mm) 65



nr kat. **12.083**
baza (mm) □ 20
H (mm) 160
L (mm) 100



nr kat. **12.084**
baza (mm) □ 24
H (mm) 180
L (mm) 95



nr kat. **12.112**
baza (mm) □ 12
H (mm) 130
L (mm) 70



nr kat. **12.115**
baza (mm) □ 15
H (mm) 150
L (mm) 75



nr kat. **12.118**
baza (mm) □ 18
H (mm) 190
L (mm) 120



nr kat. **12.121**
baza (mm) □ 21
H (mm) 190
L (mm) 115



nr kat. **12.124**
baza (mm) □ 24
H (mm) 190
L (mm) 120



nr kat. **12.150**
baza (mm) □ 12
H (mm) 330
L (mm) 63

rozety

rosettes / Rosetten / розетки

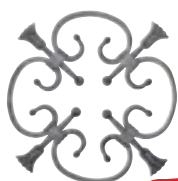

nr kat.	13.000	13.003	13.004	13.005	13.007	13.008
baza (mm)	12 x 6	□8	□8	20 x 4	10 x 5	12 x 6
H (mm)	240	250	240	250	250	300
L (mm)	240	250	240	250	250	300

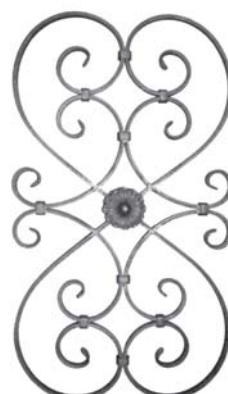
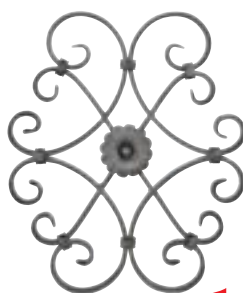
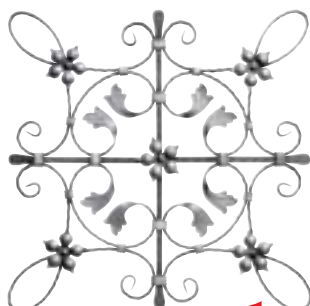

nr kat.	13.009	13.010	13.016	13.017	13.018
baza (mm)	12 x 6	12 x 6	16 x 8	16 x 8	□12
H (mm)	340	640	480	800	530
L (mm)	340	640	410	440	420

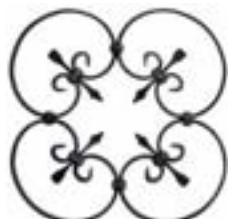

nr kat.	13.019	13.020	13.025	13.026
baza (mm)	□12	10 x 5	□12	16 x 8
H (mm)	460	380	590	590
L (mm)	410	380	590	510



nr kat. 13.027
baza (mm) 16 x 8
H (mm) 670
L (mm) 640

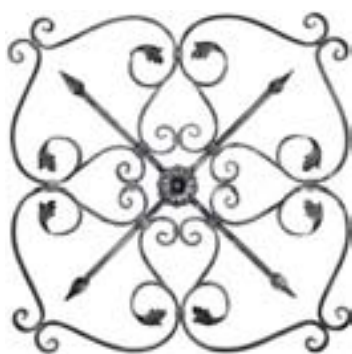

nr kat. 13.028
baza (mm) 16 x 8
H (mm) 800
L (mm) 800



nr kat. 13.029
baza (mm) 16 x 8
H (mm) 800
L (mm) 700



nr kat. 13.030
baza (mm) □ 12
H (mm) 900
L (mm) 385



nr kat. 13.032
baza (mm) □ 12
H (mm) 560
L (mm) 400



nr kat. 13.033
baza (mm) □ 12
H (mm) 600
L (mm) 370



nr kat. 13.034
baza (mm) □ 12
H (mm) 510
L (mm) 690



nr kat. 13.035
baza (mm) □ 12
H (mm) 480
L (mm) 320



nr kat. 13.036
baza (mm) □ 12
H (mm) 480
L (mm) 250



nr kat. 13.037
baza (mm) □ 12
H (mm) 450
L (mm) 340



nr kat. 13.038
baza (mm) □ 12
H (mm) 500
L (mm) 250



nr kat. 13.039
baza (mm) □ 12
H (mm) 400
L (mm) 400



nr kat. 13.040
baza (mm) □ 12
H (mm) 400
L (mm) 350



nr kat. 13.041
baza (mm) □ 12
H (mm) 400
L (mm) 300



nr kat. 13.042
baza (mm) 16 x 8
H (mm) 370
L (mm) 880



nr kat. 13.043
baza (mm) 16 x 8
H (mm) 800
L (mm) 275



nr kat. **13.044**
 baza (mm) 16 x 8
 H (mm) 800
 L (mm) 275

nr kat. **13.045**
 baza (mm) 16 x 8
 H (mm) 800
 L (mm) 300

nr kat. **13.046**
 baza (mm) 16 x 8
 H (mm) 800
 L (mm) 300

nr kat. **13.055**
 baza (mm) 16 x 8
 H (mm) 900
 L (mm) 270

nr kat. **13.056**
 baza (mm) 16 x 8
 H (mm) 870
 L (mm) 870

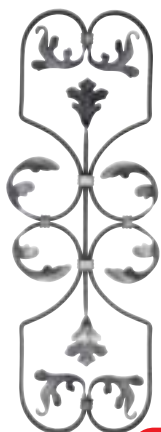

nr kat. **13.057**
 baza (mm) 16 x 8
 H (mm) 800
 L (mm) 270

nr kat. **13.058**
 baza (mm) 16 x 8
 H (mm) 800
 L (mm) 180

nr kat. **13.059**
 baza (mm) 16 x 8
 H (mm) 800
 L (mm) 180

nr kat. **22.023**
 □ 16
 950

nr kat. **13.100**
 Ø 12
 1080
 600

nr kat. **13.101**
 Ø 12
 1080
 600

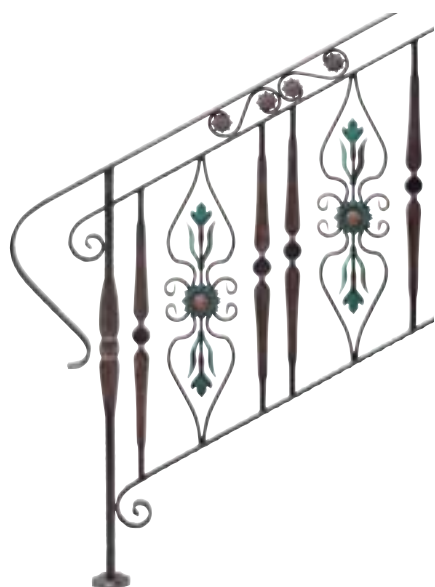

nr kat.	13.031		13.070		NOWOŚĆ
baza (mm)	12 x 6		16 x 8		
H (mm)	230		220		
L (mm)	740		1200		

nr kat.	13.071		13.072		NOWOŚĆ
baza (mm)	16 x 8		16 x 8		
H (mm)	380		380		
L (mm)	1500		1500		

nr kat.	13.073		13.074		NOWOŚĆ
baza (mm)	16 x 8		16 x 8		
H (mm)	330		330		
L (mm)	1270		1270		



nr kat.	13.102	13.103	13.104	13.105
baza (mm)	∅ 12	∅ 12	∅ 12	∅ 12
H (mm)	550	550	880	880
L (mm)	750	750	750	750



nr kat.	13.106	13.107	13.200	13.202	13.203
baza (mm)	∅ 12	∅ 12	∅ 16 - 14 - 12	∅ 14	∅ 14
H (mm)	880	880	1500	800	1000
L (mm)	600	600	800	165	215

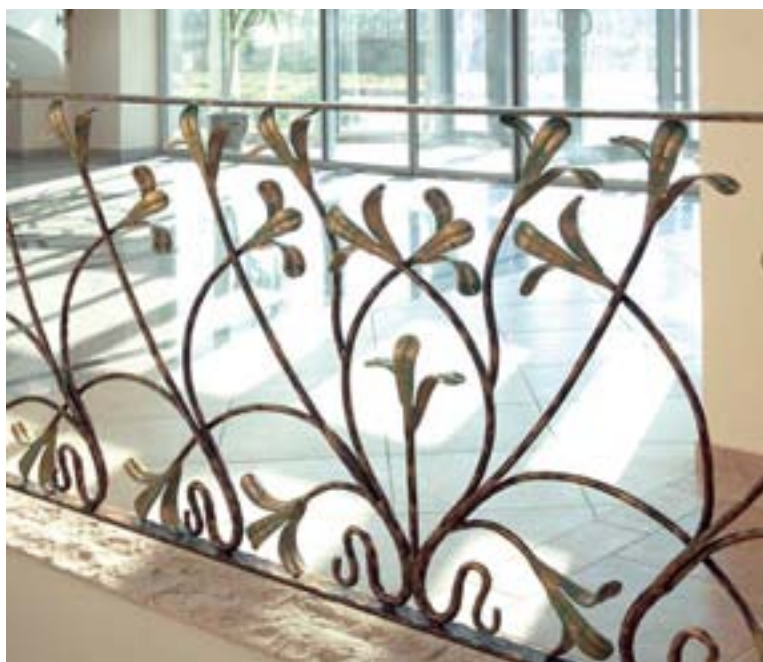

NOWOŚĆ

nr kat. **13.210**
 baza (mm) Ø 12
 H (mm) 950
 L (mm) 880



NOWOŚĆ

nr kat. **50.175**
 baza (mm) Ø 12
 H (mm) 300
 L (mm) 190



NOWOŚĆ

nr kat. **13.230**
 baza (mm) □ 12
 H (mm) 800
 L (mm) 680



NOWOŚĆ

nr kat. **13.240**
 baza (mm) □ 12
 H (mm) 385
 L (mm) 485



NOWOŚĆ

nr kat. **13.241**
 baza (mm) □ 12
 H (mm) 385
 L (mm) 540



NOWOŚĆ

nr kat. **13.242**
 baza (mm) □ 12
 H (mm) 385
 L (mm) 420



NOWOŚĆ

nr kat. **13.243**
 baza (mm) □ 12
 H (mm) 385
 L (mm) 440



NOWOŚĆ

nr kat. **13.244**
 baza (mm) □ 12
 H (mm) 516
 L (mm) 516



nowość

nr kat. **13.245**
 baza (mm) □ 12
 H (mm) Ø 385
 L (mm)



nowość

nr kat. **13.246**
 baza (mm) □ 12
 H (mm) 385
 L (mm) 445



nowość

nr kat. **13.247**
 baza (mm) □ 12
 H (mm) Ø 250
 L (mm) 355



nowość

nr kat. **13.248**
 baza (mm) □ 12
 H (mm) Ø 385
 L (mm) 440



nowość

nr kat. **13.249**
 baza (mm) □ 12
 H (mm) Ø 250
 L (mm) 430



nowość

nr kat. **13.250**
 baza (mm) □ 12
 H (mm) Ø 385
 L (mm)



nowość

nr kat. **13.251**
 baza (mm) □ 12
 H (mm) Ø 250
 L (mm) 525



nowość

nr kat. **13.252**
 baza (mm) □ 12
 H (mm) Ø 385
 L (mm)



nowość

nr kat. **13.253**
 baza (mm) □ 12
 H (mm) Ø 385
 L (mm) 545



nowość

nr kat. **13.254**
 baza (mm) □ 12
 H (mm) 420
 L (mm) 385



nowość

nr kat. **13.255**
 baza (mm) □ 12
 H (mm) 460
 L (mm) 385



NOWOŚĆ

nr kat. **13.301**
H (mm) 550
L (mm) 400



NOWOŚĆ

nr kat. **13.302**
H (mm) 660
L (mm) 470



NOWOŚĆ

nr kat. **13.303**
H (mm) 530
L (mm) 490



NOWOŚĆ

nr kat. **13.304**
H (mm) 560
L (mm) 460



NOWOŚĆ

nr kat. **13.305**
H (mm) 430
L (mm) 340

tralki kształtowe

shaped balusters / geformte Stäbe / фасонные балясины



NOWOŚĆ

nr kat. **20.001**
baza (mm) □ 12
H (mm) 950
L (mm) 125



NOWOŚĆ

nr kat. **20.002**
baza (mm) □ 14
H (mm) 950
L (mm) 125



NOWOŚĆ

nr kat. **20.003**
baza (mm) □ 12
H (mm) 950
L (mm) 125



NOWOŚĆ

nr kat. **20.004**
baza (mm) □ 14
H (mm) 950
L (mm) 125



20.010

baza (mm) □ 12
H (mm) 950
L (mm) 200



20.020

baza (mm) □ 12
H (mm) 950
L (mm) 200



20.030

baza (mm) □ 12/12 x 6
H (mm) 950
L (mm) 200



nr kat. **20.031**

baza (mm) □ 12/12 x 6
H (mm) 950
L (mm) 200



nr kat. **20.040**

baza (mm) □ 12/12 x 6
H (mm) 950
L (mm) 200



nr kat. **20.041**

baza (mm) □ 12/12 x 6
H (mm) 950
L (mm) 200



nr kat. **20.100**

baza (mm) □ 12
H (mm) 950
L (mm) 200



nr kat. **20.110**

baza (mm) □ 14
H (mm) 950
L (mm) 110



NOWOŚĆ

nr kat. **20.128**

baza (mm) 30 x 5
H (mm) 950
L (mm) 170



nr kat. **20.130**

baza (mm) 30 x 5
H (mm) 800
L (mm) 170



NOWOŚĆ

nr kat. **20.150**

baza (mm) □ 14
H (mm) 950
L (mm) 210

tralki gładkie

plain balusters / glatte Stäbe / гладкие балясины

nr kat.	21.010	21.011	21.022	21.023	21.024	21.025	21.026	21.027
baza (mm)	□ 12	□ 12	□ 12	□ 12	□ 12	□ 12	□ 12/12 x 6	□ 12/12 x 6
H (mm)	950	950	950	950	950	950	950	950
L (mm)							155	155

nr kat.	21.028	21.029	21.030	21.031	21.032	21.033	21.034	21.035
baza (mm)	□ 12/12 x 6	□ 12/12 x 6	□ 12/12 x 6	□ 12/12 x 6	□ 12/12 x 6	□ 12/12 x 6	□ 12/12 x 6	□ 12/12 x 6
H (mm)	950	950	950	950	950	950	950	950
L (mm)	155	155	210	210	210	210	165	165

nr kat.	21.036	21.037	21.038	21.039	21.040	21.041	21.042	21.043
baza (mm)	□ 12/12 x 6	□ 12/12 x 6	□ 12/12 x 6	□ 12/12 x 6	□ 12/12 x 6	□ 12/12 x 6	□ 12/12 x 6	□ 12/12 x 6
H (mm)	950	950	950	950	950	950	950	950
L (mm)	155	155	155	155	140	140	210	210

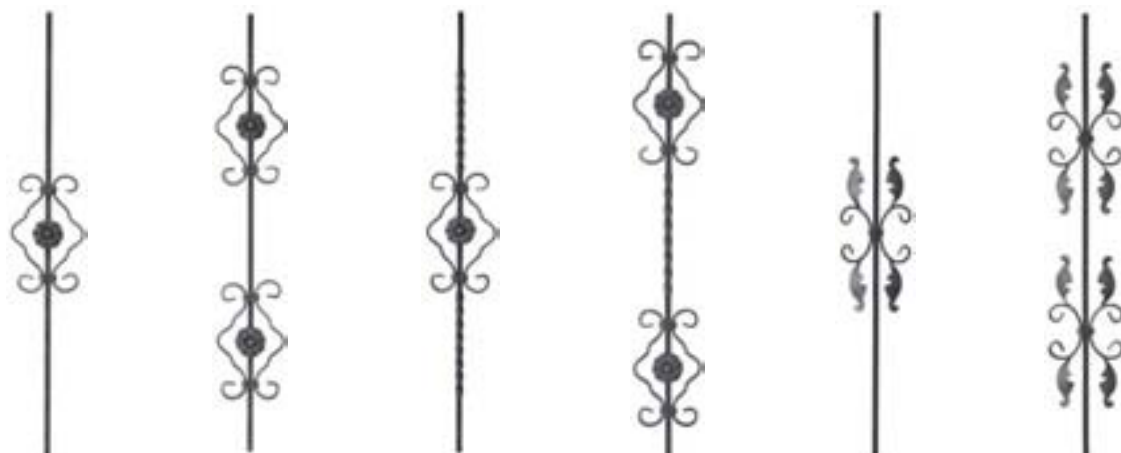

nr kat.	21.044	21.045	21.046	21.047	21.111	21.112
baza (mm)	□ 12/12 x 6	□ 12/12 x 6	□ 12/12 x 6	□ 12/12 x 6	□ 12/12 x 6	□ 12/12 x 6
H (mm)	950	950	950	950	950	950
L (mm)	165	165	165	165	155	155

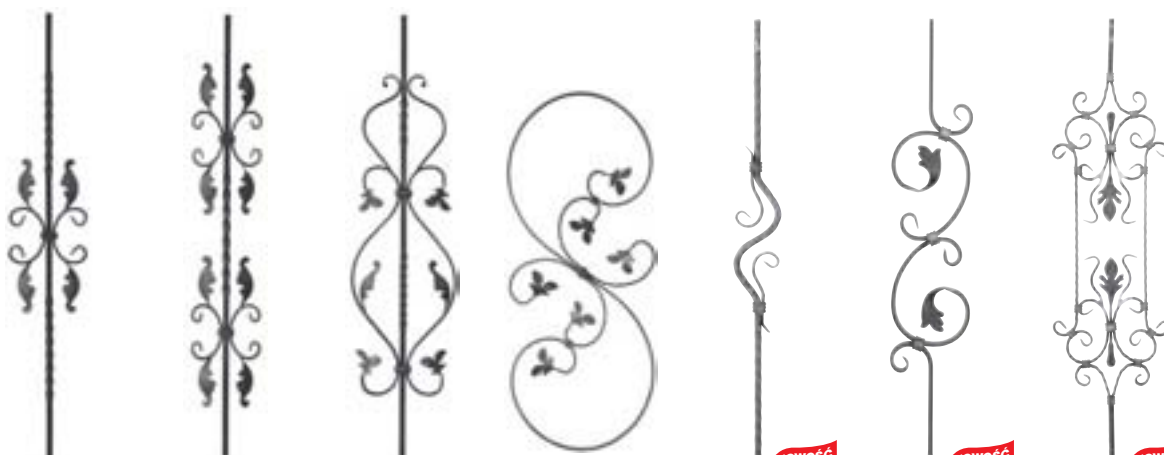

nr kat.	21.113	21.114	21.115	21.116	21.117	21.118	21.119
baza (mm)	□ 12/12 x 6	□ 12/12 x 6	□ 12/12 x 6	□ 12/12 x 6	□ 12/12 x 6	16 x 8	□ 12/12 x 6
H (mm)	950	950	950	860	950	950	950
L (mm)	155	155	230	350	95	155	270



nr kat.	21.040	21.041	21.042	21.043	21.044	21.045	21.046
baza (mm)	□ 12	□ 12	□ 12	□ 12	□ 12	□ 12	□ 12
H (mm)	950	950	950	950	950	950	950
L (mm)	200	275	165	180	180	195	200

tralki rurowe

tubular balusters / Rohrstäbe / трубчатые балясины



nr kat.	21.900	21.901	21.902	21.903
baza (mm)	Ø 30 x 1,5	Ø 30 x 1,5	Ø 30 x 1,5	Ø 30 x 1,5
H (mm)	900	900	900	900

tralki fakturowane







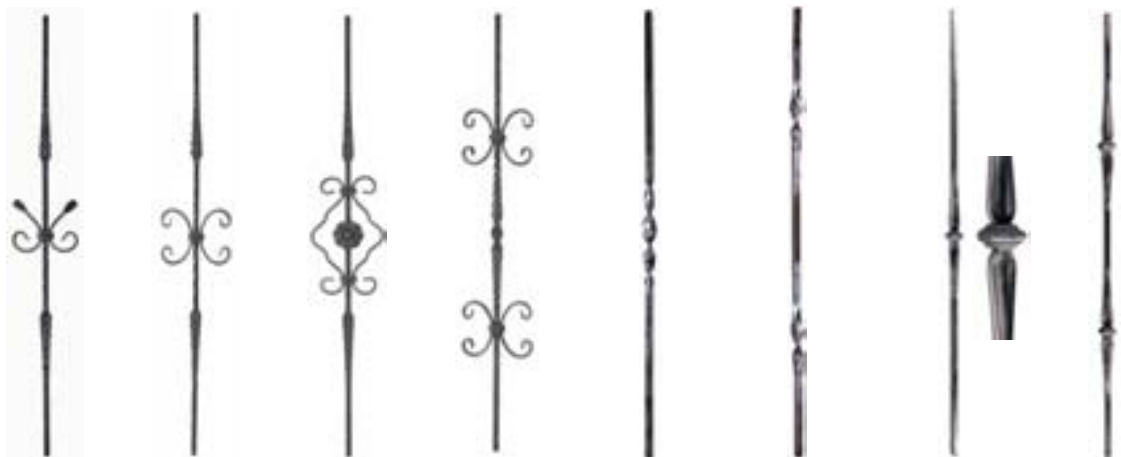

textured balusters / Strukturierte Stäbe / фактурные балясины



nr kat.	22.001	22.002	22.003	22.004	22.005	22.006	22.007	22.008
baza (mm)	Ø 14	Ø 14	□ 12	□ 12	□ 12	□ 12	□ 12	□ 12
H (mm)	950	950	950	950	950	950	950	950













nr kat.	22.009	22.010	22.011	22.012	22.013	22.014	22.019	22.020
baza (mm)	□ 12/12 x 6	□ 12/12 x 6	□ 12/12 x 6	□ 12/12 x 6	□ 12	□ 12	□ 12	□ 12
H (mm)	950	950	950	950	900	900	950	950
L (mm)	140	155	165	155	30	30	33	33

								
	NOWOŚĆ	NOWOŚĆ	NOWOŚĆ	NOWOŚĆ	NOWOŚĆ	NOWOŚĆ	NOWOŚĆ	NOWOŚĆ
nr kat.	22.023	22.051	22.052	22.053	22.100	22.103	22.104	22.105
baza (mm)	□ 16	∅ 12	∅ 12	∅ 12	□ 12	□ 12	□ 12	□ 12
H (mm)	950	1000	1000	1000	950	950	950	950
L (mm)		120	50	50	140	185	180	180

tralki kute

forged balusters / Schmiedestäbe / кованные балюсины

								
nr kat.	23.001	23.002	23.003	23.004	23.005	23.006	23.007	23.008
baza (mm)	∅ 12	∅ 12	□ 14	□ 14	∅ 12	∅ 12	□ 12	□ 12
H (mm)	950	950	950	950	950	950	950	950

								
nr kat.	23.009	23.010	23.011	23.012	23.013	23.014	23.015	23.016
baza (mm)	□ 14	□ 14	□ 14	□ 14	□ 14	□ 14	□ 14	□ 14
H (mm)	950	950	950	950	950	950	950	950
								NOWOŚĆ

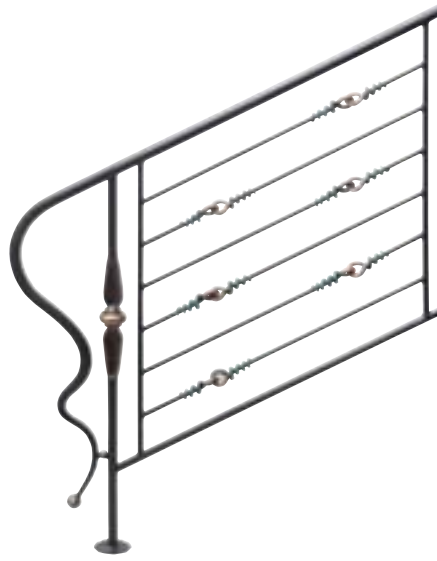

nr kat.
baza (mm)
H (mm)

23.017
Ø 12
950

23.018
Ø 12
950

23.019
Ø 12
950

23.020
Ø 12
950

23.021
Ø 12
950

23.022
Ø 12
950

23.023
Ø 12
950



nr kat.
baza (mm)
H (mm)

23.024
□ 14
950

23.025
□ 14
950

23.026
□ 14
950







23.027
□ 20
950

23.028
□ 12
950

23.029
□ 12
950









NOWOŚĆ









NOWOŚĆ

						
	NOWOŚĆ	NOWOŚĆ	NOWOŚĆ	NOWOŚĆ	NOWOŚĆ	NOWOŚĆ
nr kat.	23.060	23.061	23.062	23.063	23.064	23.065
baza (mm)	□ 16	□ 16	□ 16	□ 14	□ 16	□ 16
H (mm)	950	950	950	950	950	950
L (mm)	75	40	115	105	105	60

słupy balustradowe

baluster posts / Brüstungspfosten / балюстрадные столбы

									
		NOWOŚĆ	NOWOŚĆ						NOWOŚĆ
nr kat.	24.010	24.011	24.023	24.101	24.105	24.106	24.110	24.111	24.112
baza (mm)	□ 20	□ 20	□ 25	□ 25	□ 25	□ 25	∅ 30	∅ 25	∅ 28
H (mm)	1200	1200	1200	1200	1200	1200	1200	1200	1200

									
	NOWOŚĆ					NOWOŚĆ		NOWOŚĆ	NOWOŚĆ
nr kat.	24.151	24.254	24.255	24.257	24.259	24.261	24.266	24.270	24.271
baza (mm)	□ 25	□ 25	□ 25	□ 25	□ 25	□ 25	□ 25	□ 25	□ 30
H (mm)	1200	1200	1200	1200	1200	1200	1200	1200	1000



nr kat. **24.300**
baza (mm) Ø 30
H (mm) 1100
L (mm) 400



nr kat. **24.301**
baza (mm) Ø 35
H (mm) 1000
L (mm) 580



nr kat. **24.302**
baza (mm) □ 30x10
H (mm) 1000
L (mm) 410



nr kat. **24.303**
baza (mm) □ 30x30
H (mm) 1100
L (mm) 300

nowość



nr kat. **24.400**
baza (mm) Ø 40x2
H (mm) 1200

płaskowniki, poręcze

flat bars, railings / Flachstangen, Geländer /
полосы, поручни

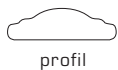

nr kat. **30.001**
baza (mm) 40 x 12
H (mm) 3000
L (mm)



nr kat. **30.001.01**
baza (mm) 40 x 12
H (mm) 100
L (mm) 350



nr kat. **30.001.02**
baza (mm) 40 x 12
H (mm) 680
L (mm)



nr kat. **30.001.03**
baza (mm) 40 x 12
H (mm) 180
L (mm) 300



nr kat. **30.001.04**
baza (mm) 40 x 12
H (mm) 400
L (mm)



nr kat. **30.001.05**
baza (mm) 40 x 12
H (mm) 300
L (mm) 300

nr kat. **30.001.06**
baza (mm) 40 x 12
H (mm) 250
L (mm) 250



nr kat.	30.002	30.002.01	30.002.02	30.002.03	30.002.04	30.002.05	30.002.06
baza (mm)	50 x 14	50 x 14	50 x 14	50 x 14	50 x 14	50 x 14	50 x 14
H (mm)	3000	100	680	180	400	300	250
L (mm)		350		300		300	250

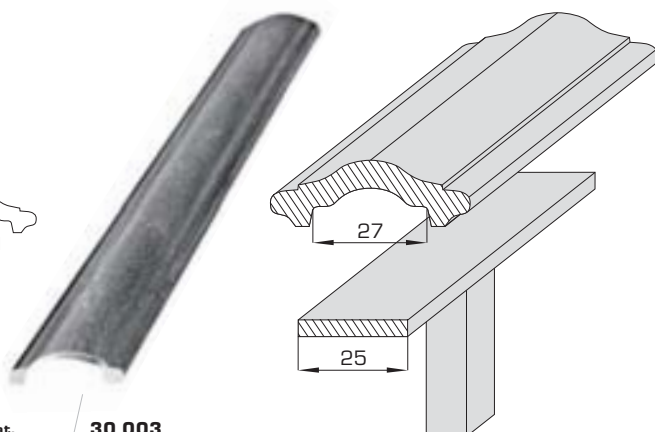

nr kat.	30.003
baza (mm)	45 x 15
H (mm)	3000
L (mm)	

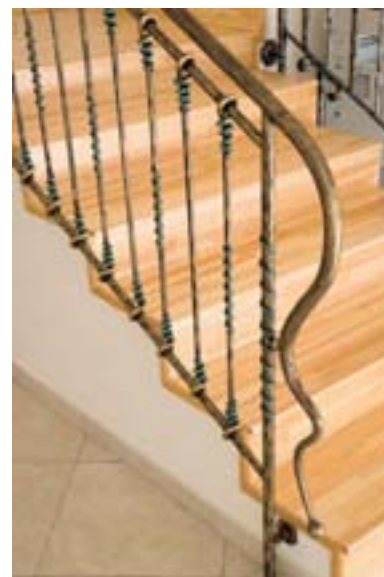

nr kat.	30.008	30.008.01	30.008.02	30.008.03	30.008.04	30.008.05	30.008.06
baza (mm)	40 x 8	40 x 8	40 x 8	40 x 8	40 x 8	40 x 8	40 x 8
H (mm)	3000	100	680	180	400	300	250
L (mm)		350		300		300	250



profil



nr kat.	30.009	30.009.01	30.009.02	30.009.03	30.009.04	30.009.05	30.009.06
baza (mm)	40 x 8	40 x 8	40 x 8	40 x 8	40 x 8	40 x 8	40 x 8
H (mm)	3000	100	680	180	400	300	250
L (mm)		350		300		300	250



profil



nr kat.	30.010	30.010.01	30.010.02	30.010.03	30.010.04	30.010.05	30.010.06
baza (mm)	40 x 8	40 x 8	40 x 8	40 x 8	40 x 8	40 x 8	40 x 8
H (mm)	3000	100	680	180	400	300	250
L (mm)		350		300		300	250



profil



nr kat.	30.103	30.103.01	30.103.02	30.103.03	30.103.04	30.103.05	30.103.06
baza (mm)	40 x 8	40 x 8	40 x 8	40 x 8	40 x 8	40 x 8	40 x 8
H (mm)	3000	100	680	180	400	300	250
L (mm)		350		300		300	250



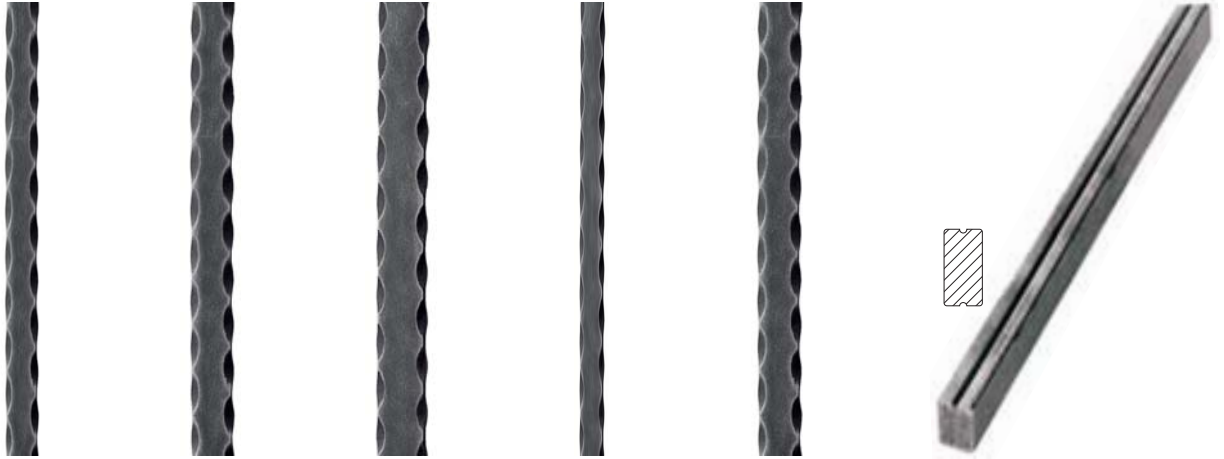

nr kat.	30.100	30.101	30.102	30.200	30.202	30.220
baza (mm)	20 x 5	25 x 6	30 x 6	12 x 6	20 x 10	16 x 8
H (mm)	3000	3000	3000	3000	3000	3000
przekrój						

taśmy

banding materials / Bände / ленты



2 ≠ 12 x 6

3 ≠ 12 x 6

4 ≠ 12 x 6

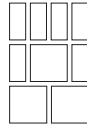

nr kat.	31.122	31.124	31.123	31.101	31.102	31.103
baza (mm)	14 x 4	14 x 4	14 x 4	25 x 8	30 x 8	40 x 8
H (mm)				3000	3000	3000
przekrój						



nr kat.	31.100	31.200	31.300	31.400	31.402
baza (mm)	14 x 4	14 x 4	14 x 4	14 x 3	20 x 4
H (mm)	4000	4000	4000	3000	3000
przekrój					

taśma miękka

pręty

bars
Stäbe
прутья



nr kat.	32.001	32.002	32.003	32.004	32.005	32.007	32.100	32.101	32.102
baza (mm)	□ 12	□ 12	□ 14	□ 14	□ 16	□ 20	∅ 10 - ∅ 12	∅ 12 - ∅ 16	∅ 16 - ∅ 20
H (mm)	3000	6000	3000	6000	3000	3000	1100	1100	1100
przekrój	□	□	□	□	□	□	○	○	○



nr kat.	32.111	32.112	32.113	32.114	32.115	32.117	32.119	32.200	32.201	32.202	32.203
baza (mm)	∅ 8	∅ 10	∅ 12	∅ 14	∅ 16	∅ 20	∅ 24	∅ 25 [6x ∅ 8]	∅ 30 [6x ∅ 10]	∅ 38 [6x ∅ 12]	∅ 48 [8x ∅ 12]
H (mm)	3000	3000	3000	3000	3000	3000	3000	1000/2500	1000/2500	1000/2500	1000/2500
przekrój	○	○	○	○	○	○	○	○	○	○	○

pręty kształtowe i otworowane [do krat]

shaping bars and bars with openings (for gratings) / geformte Stäbe und Lochstäbe (für Fenstergitter) / фасонные прутья и прутья с отверстиями (для решеток)



nr kat.	33.001	33.013	33.023	33.100	33.201	33.202
baza (mm)	□ 14	□ 14	∅ 14	□ 14	□ 12x6	□ 16x8
H (mm)	2000	2000	2000	2000	2000x65	2000x65
					NOWOŚĆ	NOWOŚĆ

profile zamknięte – kwadratowe fakturowane

closed sections – square, textured / Stäbe / прутья



nr kat.	34.001	34.002	34.003	34.004	34.005	34.006	34.007	34.008	34.009	34.010	34.011
baza (mm)	20 x 20 x 2	20 x 20 x 2	20 x 20 x 2	25 x 25 x 2,5	25 x 25 x 2,5	25 x 25 x 2,5	30 x 30 x 2,5	30 x 30 x 2,5	30 x 30 x 2,5	40 x 40 x 2,5	40 x 40 x 2,5
H (mm)	2000	3000	6000	2000	3000	6000	2000	3000	6000	2000	3000
przekrój											

nr kat.	34.012	34.016	34.017	34.018	34.019	34.020	34.021	34.022	34.023	34.024
baza (mm)	40 x 40 x 2,5	60 x 60 x 2,5	60 x 60 x 2,5	60 x 60 x 2,5	80 x 80 x 2,5	80 x 80 x 2,5	80 x 80 x 2,5	100 x 100 x 3	100 x 100 x 3	100 x 100 x 3
H (mm)	6000	2000	3000	6000	2000	3000	6000	2000	3000	6000
przekrój										

profile zamknięte – prostokątne fakturowane









































closed sections – rectangular, textured / geschlossene Profile – quadratisch, strukturiert / замкнутые профили – квадратные фактурные











nr kat.	34.104	34.105	34.106	34.110	34.111	34.112	34.119	34.120	34.121
baza (mm)	40 x 20 x 2	40 x 20 x 2	40 x 20 x 2	50 x 30 x 2,5	50 x 30 x 2,5	50 x 30 x 2,5	60 x 40 x 2,5	60 x 40 x 2,5	60 x 40 x 2,5
H (mm)	2000	3000	6000	2000	3000	6000	2000	3000	6000
przekrój									









groty, szpice, zwieńczenia









spears, points, tops / Pfahlspitzen, Spitzen, Verzierungen / замкнутые профили - прямоугольные фактурные









								
nr kat. 40.001	nr kat. 40.002	nr kat. 40.003	nr kat. 40.006	nr kat. 40.007	nr kat. 40.008	nr kat. 40.011	nr kat. 40.012	
baza (mm) Ø 15	baza (mm) Ø 15	baza (mm) Ø 15	baza (mm) Ø 25	baza (mm) Ø 30	baza (mm) Ø 18	baza (mm) Ø 12	baza (mm) Ø 15	
H (mm) 150	H (mm) 150	H (mm) 160	H (mm) 110	H (mm) 125	H (mm) 110	H (mm) 100	H (mm) 125	
L (mm) 55	L (mm) 66	L (mm) 63	L (mm) 55	L (mm) 65	L (mm) 48	L (mm) 45	L (mm) 55	
								
nr kat. 40.013	nr kat. 40.015	nr kat. 40.016	nr kat. 40.045	nr kat. 40.041	nr kat. 40.048	nr kat. 40.049	nr kat. 40.050	nr kat. 40.051
baza (mm) Ø 16	baza (mm) Ø 15	baza (mm) Ø 20	baza (mm) Ø 13	baza (mm) Ø 13	baza (mm) Ø 20	baza (mm) Ø 26	baza (mm) Ø 20	baza (mm) Ø 25
H (mm) 145	H (mm) 74	H (mm) 99	H (mm) 130	H (mm) 125	H (mm) 110	H (mm) 135	H (mm) 130	H (mm) 160
L (mm) 120	L (mm) 55	L (mm) 72	L (mm) 53	L (mm) 60	L (mm) 60	L (mm) 70	L (mm) 70	L (mm) 90
								
nr kat. 40.052	nr kat. 40.052.02	nr kat. 40.053	nr kat. 40.055	nr kat. 40.056	nr kat. 40.057	nr kat. 40.058	nr kat. 40.059	
baza (mm) Ø 12	baza (mm) Ø 12	baza (mm) Ø 17	baza (mm) Ø 20	baza (mm) Ø 25	baza (mm) Ø 38	baza (mm) Ø 20	baza (mm) Ø 25	
H (mm) 130	H (mm) 130	H (mm) 155	H (mm) 80	H (mm) 125	H (mm) 140	H (mm) 120	H (mm) 135	
L (mm) 60	L (mm) 60	L (mm) 70	L (mm) 45	L (mm) 65	L (mm) 80	L (mm) 55	L (mm) 65	
								
nr kat. 40.060	nr kat. 40.060.01	nr kat. 40.060.02	nr kat. 40.061	nr kat. 40.065	nr kat. 40.066	nr kat. 40.067	nr kat. 40.068	
baza (mm) Ø 20	baza (mm) Ø 16	baza (mm) Ø 20	baza (mm) Ø 26	baza (mm) □ 12	baza (mm) □ 14	baza (mm) □ 12	baza (mm) □ 14	
H (mm) 115	H (mm) 82	H (mm) 115	H (mm) 140	H (mm) 120	H (mm) 140	H (mm) 150	H (mm) 180	
L (mm) 58	L (mm) 40	L (mm) 58	L (mm) 70	L (mm) 42	L (mm) 47	L (mm) 40	L (mm) 43	
								
nr kat. 40.071	nr kat. 40.071.01	nr kat. 40.072	nr kat. 40.072.01	nr kat. 40.073	nr kat. 40.074	nr kat. 40.075		
baza (mm) Ø 25	baza (mm) Ø 20	baza (mm) Ø 25	baza (mm) Ø 20	baza (mm) Ø 30	baza (mm) Ø 32	baza (mm) Ø 25		
H (mm) 125	H (mm) 95	H (mm) 135	H (mm) 98	H (mm) 160	H (mm) 190	H (mm) 135		
L (mm) 40	L (mm) 30	L (mm) 40	L (mm) 33	L (mm) 50	L (mm) 55	L (mm) 40		









							
nr kat.	40.077	40.077.02	40.078	40.079	40.080	40.081	40.083
baza (mm)	∅ 32	∅ 25	□ 15	□ 18 x 14	∅ 16	∅ 16	∅ 25
H (mm)	125	110	140	100	155	160	125
L (mm)	60	50	60	55	65	65	45









							
nr kat.	40.084	40.085	40.088.01	40.089	40.090	40.092	40.092.01
baza (mm)	∅ 33	∅ 40	□ 20	□ 25	□ 40	□ 20	□ 15
H (mm)	140	190	100	160	150	125	82
L (mm)	57	68	20	25	40	30	20









								
nr kat.	40.093	40.094	40.095	40.096	40.097	40.098.03	40.098.02	40.098.01
baza (mm)	□ 32	□ 40	□ 12	∅ 18	□ 24	∅ 24	∅ 30	∅ 33
H (mm)	160	190	95	125	60	88	120	150
L (mm)	40	50	27	40	35	28	35	40









								
nr kat.	40.099	40.099.01	40.099.02	40.099.03	40.100	40.101	40.102	40.103
baza (mm)	∅ 19	□ 25	□ 32	□ 40	∅ 16	∅ 21	∅ 13	∅ 15
H (mm)	210	120	160	200	160	165	140	180
L (mm)	75	67	92	117	90	70	50	60

									
nr kat.	40.104	40.105	40.106	40.107	40.109	40.110	40.111	40.112	40.112.01
baza (mm)	∅ 16	∅ 25	□ 15	□ 15	∅ 50	□ 18	□ 26	∅ 40	∅ 16
H (mm)	160	160	140	140	170	250	290	200	120
L (mm)	65	70	80	80	85	80	75	100	73

									
nr kat.	40.113	40.114	40.117	40.118	40.125	40.126	40.132	40.133	40.138
baza (mm)	∅ 32	□ 20	∅ 29	∅ 35	□ 20	∅ 33	□ 12	□ 12	□ 14
H (mm)	210	270	180	205	135	130	170	150	150
L (mm)		70	60	65	90	47	30	30	30

									
nr kat.	40.140	40.142	40.150	40.151	40.153	40.155	40.156	40.157	40.158
baza (mm)	□ 16	□ 23	∅ 12	□ 12	□ 16	□ 20	∅ 16	∅ 26	∅ 24
H (mm)	57	115	92	120	107	148	132	134	155
L (mm)	38	96	35	35	25	35	85	64	68

								
nr kat.	40.160	40.161	40.162	40.163	40.170	40.171	40.174	40.175
baza (mm)	□ 13	□ 16	□ 16	□ 26	□ 12	□ 14	□ 12	□ 14
H (mm)	145	183	105	140	200	200	200	200
L (mm)	61	76	60	88				

								
nr kat.	40.200	40.201	40.205	40.210	40.211	40.212	40.300	40.301
baza (mm)	∅ 22	∅ 27	□ 14	□ 15	□ 18	□ 23		
H (mm)	80	110	130	82	110	140	150	160
L (mm)			60	15	18	23	85	110

przekuwki, nasadki

slugs, caps / Rohrteile, Aufsätze / кованные элементы, насадки



nr kat.	41.001	41.001.01	41.002	41.002.01	41.003	41.004	41.005	41.006
baza (mm)	□ 12,5		□ 12,5		□ 14,5	□ 14,5	∅ 14,5	∅ 14,5
H (mm)	39	39	67	67	44	67	39	67
L (mm)	40	40	40	40	45	45	45	45



nr kat.	41.007	41.008	41.050	41.060	41.070
baza (mm)	□ 16,5	□ 16,5	∅ 35,5	□ 30,5	□ 27
H (mm)	44	67	80	80	215
L (mm)	45	45	69	69	63



nr kat.	41.102	41.104	41.105	41.114	41.115	41.202	41.204	41.206	41.207
baza (mm)	□ 12,5	□ 14,5	□ 16,5	∅ 14,5	∅ 16,5	□ 12,5	□ 14,5	□ 20,5	□ 25,5
H (mm)	22	22	22	22	22	22	22	35	35
L (mm)	40	40	40	40	40	33	38	55	55



nr kat.	41.306	41.307	41.311	41.312	41.315	41.316	41.317	41.318	41.400	41.401
baza (mm)	□ 14,5	□ 14,5	∅ 14,5	∅ 14,5	□ 16	□ 16	∅ 16	∅ 16	∅ 12	□ 12
H (mm)	70	130	70	130	75	148	75	128	140	140
L (mm)	35	35	35	35	42	48	38	40	28	26

							
nr kat.	41.402	41.403	41.404	41.405	41.406	41.450	41.451
baza (mm)	□ 14	□ 14	□ 12	□ 12	□ 12	∅ 14	∅ 14
H (mm)	160	80	200	200	200	95	120
L (mm)	25	35	56	60	50	40	40

gałki







knobs / Knöpfe / набалдашники

								
nr kat.	42.000	42.001	42.002	42.003	42.004	42.005	42.006	42.007
baza (mm)	∅ 28	∅ 40	∅ 100	∅ 50	□ 25	□ 40	∅ 27	∅ 42
H (mm)	80	90	180	90	60	85	60	85

							
nr kat.	42.011	42.013	42.016	42.017	42.020	42.021	42.022
baza (mm)	∅ 30	∅ 60	∅ 30	∅ 35	∅ 52	∅ 50	∅ 75
H (mm)	45	70	45	65	95	160	120

kule pełne, gładkie

plain full spheres / volle, glatte Kugeln / шары сплошные гладкие

							
nr kat.	43.015	43.020	43.025	43.030	43.035	43.040	43.050
baza (mm)	∅ 15	∅ 20	∅ 25	∅ 30	∅ 35	∅ 40	∅ 50

kule pełne, fakturowane

textured full spheres / volle, strukturierte Kugeln / шары сплошные фактурные



nr kat.	43.120	43.125	43.130	43.135	43.140	43.150	43.230	43.240	43.250
baza (mm)	Ø 20	Ø 25	Ø 30	Ø 35	Ø 40	Ø 50	Ø 30	Ø 40	Ø 50

kule puste, gładkie

plain hollow spheres / glatte Hohlkugeln / шары полые гладкие



nr kat.	43.615	43.620	43.625	43.630	43.640	43.650	43.660	43.670	43.680
baza (mm)	Ø 15	Ø 20	Ø 25	Ø 30	Ø 40	Ø 50	Ø 60	Ø 70	Ø 80



nr kat.	43.690	43.700	43.720	43.750	43.800
baza (mm)	Ø 90	Ø 100	Ø 120	Ø 150	Ø 200

maskownice, szyldy maskujące

masking frames, escutcheons / Blenden, Blendschilder / маскировочные элементы



nr kat.	44.001	44.004	44.006	44.010	44.011	44.013	44.014
baza (mm)	12,5	21	26	90	100	30	60
H (mm)	50	70	90	90	100	100	60
L (mm)	50	70	90	90	100	100	60
grubość (mm)	6	8	8	5	10	10	5



nr kat.	44.017	44.018	44.020	44.022	44.026	44.029
baza (mm)	65	13	100	26	Ø 65	Ø 90
H (mm)	65	65	100	100	4	4
L (mm)	65	65	100	100	4	4
grubość (mm)	4	4	4	4	4	4



nr kat. **44.034**
 baza (mm) /
 H (mm) / Ø 110
 L (mm) /
 grubość (mm) / 4



nr kat. **44.036**
 baza (mm) / 26
 H (mm) / Ø 110
 L (mm) /
 grubość (mm) / 4



nr kat. **44.040**
 baza (mm) / 60
 H (mm) / 60
 L (mm) / 60
 grubość (mm) / 4



nr kat. **44.043**
 baza (mm) / 80
 H (mm) / 80
 L (mm) / 80
 grubość (mm) / 4



nr kat. **44.047**
 baza (mm) / 14
 H (mm) / 12
 L (mm) / 60 x 60
 grubość (mm) / 2,5



nr kat. **44.050**
 baza (mm) / 26
 H (mm) / 18
 L (mm) / 80 x 80
 grubość (mm) / 2,5



nr kat. **44.060**
 baza (mm) / 14,5
 H (mm) / Ø 90
 L (mm) /
 grubość (mm) / 4



nr kat. **44.066** *NOWOŚĆ*
 baza (mm) / 62
 H (mm) / 62
 L (mm) / 62
 grubość (mm) / 2



nr kat. **44.067** *NOWOŚĆ*
 baza (mm) / 12
 H (mm) / 62
 L (mm) / 62
 grubość (mm) / 2



nr kat. **44.068** *NOWOŚĆ*
 baza (mm) / 16
 H (mm) / 62
 L (mm) / 62
 grubość (mm) / 2



nr kat. **44.069** *NOWOŚĆ*
 baza (mm) / 24
 H (mm) / 62
 L (mm) / 62
 grubość (mm) / 2



nr kat. **44.070** *NOWOŚĆ*
 baza (mm) / 75
 H (mm) / 75
 L (mm) / 75
 grubość (mm) / 2,5



nr kat. **44.071** *NOWOŚĆ*
 baza (mm) / 12
 H (mm) / 75
 L (mm) / 75
 grubość (mm) / 2,5



nr kat. **44.072** *NOWOŚĆ*
 baza (mm) / 16
 H (mm) / 75
 L (mm) / 75
 grubość (mm) / 2,5



nr kat. **44.073** *NOWOŚĆ*
 baza (mm) / 24
 H (mm) / 75
 L (mm) / 75
 grubość (mm) / 2,5



nr kat. **44.074** *NOWOŚĆ*
 baza (mm) / Ø 75
 H (mm) / 2,5
 L (mm) / 2,5



nr kat. **44.075** *NOWOŚĆ*
 baza (mm) / 12
 H (mm) / Ø 75
 L (mm) / Ø 75
 grubość (mm) / 2,5



nr kat. **44.076** *NOWOŚĆ*
 baza (mm) / 16
 H (mm) / Ø 75
 L (mm) /
 grubość (mm) / 2,5



nr kat. **44.077** *NOWOŚĆ*
 baza (mm) / 24
 H (mm) / Ø 75
 L (mm) /
 grubość (mm) / 2,5



nr kat. **44.134**
 baza (mm) / 20
 H (mm) / Ø 60
 L (mm) / 2,5



nr kat. **44.136**
 baza (mm) / 20
 H (mm) / Ø 40
 L (mm) / 2,5



nr kat. **44.137**
 baza (mm) / 20
 H (mm) / Ø 30
 L (mm) / 2,5



nr kat. **44.119**
 baza (mm) / 30,5
 H (mm) / 20
 L (mm) / 80 x 80



nr kat. **44.121**
 baza (mm) / 40,5
 H (mm) / 20
 L (mm) / 80 x 80



nr kat. **44.122**
 baza (mm) / 25,5
 H (mm) / 20
 L (mm) / 60 x 60



nr kat. **44.123**
 baza (mm) / 30,5
 H (mm) / 20
 L (mm) / 60 x 60



nr kat. **44.126**
 baza (mm) / 20,5
 H (mm) / 20
 L (mm) / 50 x 50









nr kat. **44.127**
 baza (mm) / 12,5
 H (mm) / 20
 L (mm) / 40 x 40



nr kat. **44.128**
 baza (mm) / 14,5
 H (mm) / 20
 L (mm) / 40 x 40



nr kat. **44.129**
 baza (mm) / 16,5
 H (mm) / 20
 L (mm) / 40 x 40

						
nr kat.	44.140	44.141	44.146	44.147	44.148	44.149
baza (mm)	Ø 25	Ø 32	12	14	16	20
H (mm)	25	25	19	19	19	22
L (mm)	Ø 80	Ø 80	44	44	44	57
grubość (mm)	1,5	1,5	1,2	1,2	1,2	1,2







					
nr kat.	44.150	44.151	44.200	44.201	44.202
baza (mm)	25	30		120	145
H (mm)	30	30	155	50	60
L (mm)	80	80	70	4	4
grubość (mm)	1,5	1,5	4	4	4







					
nr kat.	44.203	44.204	44.205		
H (mm)	200	280	160		
L (mm)	85	120	105		
grubość (mm)	4	5	6		

kwiaty, liście i motywy roślinne

flowers, leaves, flower ornaments / Blumen, Blätter, Ornamente mit Pflanzmotiven / цветы, листья, растительные орнаменты

							
nr kat.	50.001	50.003	50.004	50.005	50.006	50.007	50.008
Ø (mm)	95	95	62	60	90	98	115
otwór (mm)				10	10	12	12
grubość (mm)	5	5	4	3	3	3	3

							
nr kat.	50.009	50.010	50.011	50.012	50.013	50.014	50.015
Ø (mm)	60	68	97	120	95	60	95
otwór (mm)		12	12	12		10	18
grubość (mm)	3	1,5	1,5	2	2,5	3	3







						
nr kat.	50.016	50.017	50.018	50.021	50.021.01	50.022
Ø (mm)	62	60	40	90	135	85
otwór (mm)					10	10
grubość (mm)	2,5	2	4	2	2	2

						
nr kat.	50.023	50.024	50.025	50.026	50.027	50.028
Ø (mm)	45	70	115	65	95	120
grubość (mm)	1,5	1,5	1,5	3	3	3

						
nr kat.	50.029	50.030	50.031	50.032	50.033	50.034
H (mm)	5	10	20			45
Ø (mm)	46	70	115	80	60	Ø 75
grubość (mm)	1,5	1,5	1,5	1,5	1,5	2







						
nr kat.	50.100	50.101	50.102	50.103	50.104	50.105
H (mm)	450	100	240	60	240	55
L (mm)	160	70	140	45	140	30
grubość (mm)						

							
nr kat.	50.106	50.107	50.108	50.109	50.110	50.111	50.112
H (mm)	70	50	45	300	50	70	50
L (mm)	50	40	33	70	50	50	40
grubość (mm)	2	2	1		1,5	2	2

							
nr kat.	50.113	50.114	50.115	50.116	50.117	50.118	50.119
H (mm)	400	460	480	490	270	270	60
L (mm)	150	170	210	250	40	40	
grubość (mm)	2,5	2,5	2,5	2,5	40	40	

						
nr kat.	50.120	50.121	50.122	50.123	50.130	50.131
H (mm)	350	350	80	110	400	300
L (mm)	160	50	40	40	115	90
grubość (mm)			2	2		

							
nr kat.	50.132	50.133	50.134	50.135	50.136	50.137	50.138
H (mm)	145	115	85	260	220	195	160
L (mm)	90	70	50				
grubość (mm)	2	2	2	3	3	3	3

						
nr kat.	50.140	50.141	50.142	50.143	50.144	50.146
H (mm)	420	380	340	130	75	75
L (mm)	220	150	140	42	20	65
grubość (mm)				2	20	20
Ø (mm)						20



nr kat.	50.150	50.151	50.152	50.153	50.154	50.155
H (mm)	175	145	105	70	56	65
L (mm)	95	75	55	Ø 25	Ø 20	45
grubość (mm)	2	2	2			5



nr kat.	50.156	50.157	50.158	50.159	50.160	50.161	50.162
H (mm)	150	115	85	70	105	75	50
L (mm)	150	125	95	70	100	75	50
grubość (mm)	2,5	2	2	1,5	1,5	1,5	1,5



nr kat.	50.165	50.166	50.170	52.211	52.212	52.216	52.217
H (mm)	160	120	200	170	200	180	160
L (mm)	60	60	70	100	140	28	43
grubość (mm)						5	5











nr kat.	50.175	50.180	50.181	50.182	50.183
H (mm)	300	135	130	105	75
L (mm)	190	35	195	155	115
grubość (mm)	Ø 12		2	2	2











nr kat.	50.184	50.185	50.186	50.187
H (mm)	235	210	140	85
L (mm)	230	180	110	45
grubość (mm)	2,5	2,5	2,5	5

							
	NOWOŚĆ	NOWOŚĆ	NOWOŚĆ	NOWOŚĆ	NOWOŚĆ	NOWOŚĆ	NOWOŚĆ
nr kat.	50.188	50.189	50.190	50.191	50.192	50.193	50.194
H (mm)	410	275	250	160	225	210	210
L (mm)	165	105	45	110	60	135	135
grubość (mm)			2	2			

							
	NOWOŚĆ	NOWOŚĆ	NOWOŚĆ	NOWOŚĆ	NOWOŚĆ	NOWOŚĆ	NOWOŚĆ
nr kat.	50.195	50.196	50.197	50.198	50.199	50.200	50.201
H (mm)	210	200	200	500	305	200	145
L (mm)	75	110	110			115	90
grubość (mm)				2	2	2	2

								
nr kat.	51.001	51.002	51.003	51.004	51.005	51.006	51.007	51.008
H (mm)	100	100	100	100	80	80	115	115
L (mm)	60	80	50	50	80	80	40	40
grubość (mm)	3	3	3	3	3	3	2,5	2,5

								
nr kat.	51.009	51.010	51.015	51.016	51.017	51.018	51.019	51.020
H (mm)	125	125	100	100	80	80	120	120
L (mm)	80	80	70	70	50	50	100	100
grubość (mm)	2,5	2,5	3	3	3	3	2	2



nr kat.	51.059	51.060	51.061	51.062	51.063	51.064	51.069	51.070
H (mm)	190	190	110	110	90	90	80	80
L (mm)	65	65	40	40	30	30	60	60
grubość (mm)	2,5	2,5	2,5	2,5	2	2	3	3



nr kat.	51.073	51.074	51.077	51.078	51.080	51.081
H (mm)	55	55	110	110	108	110
L (mm)	70	70	75	75	45	47
grubość (mm)	2,5	2,5	3	3	2	2



nr kat.	51.082	51.099	51.100	51.101	51.102
H (mm)	150	105	100	135	165
L (mm)	47	50	70	32	60
grubość (mm)	2	3	4	3	3



nr kat.	51.103	51.104	51.105	51.106	51.107	51.108	51.109
H (mm)	165	300	275	430	330	330	180
L (mm)	70	70	50	110	100	100	50
grubość (mm)	4	4	4	6	5	4	4



nr kat.	51.110	51.111	51.112	51.113	51.114
H (mm)	150	100	100	160	160
L (mm)	80	80	80	90	90
grubość (mm)	1,5	4	4	5	5



nr kat.	51.115	51.116	51.117	51.118
H (mm)	215	215	255	255
L (mm)	175	175	155	155
grubość (mm)	4	4	4	4



nr kat.	51.119	51.120	51.121	51.122	51.123	51.124
H (mm)	270	270	200	200	295	295
L (mm)	145	145	95	95	175	175
grubość (mm)	2	2	2	2	2	2



nr kat.	51.125	51.126	51.127	51.128	51.129	51.130
H (mm)	230	230	164	164	240	240
L (mm)	135	135	130	130	140	140
grubość (mm)	2	2	2	2	2	2



nr kat.	51.131	51.132	51.133	51.134
H (mm)	245	242	180	180
L (mm)	130	170	170	170
grubość (mm)	2,5	2	2	2



NOWOŚĆ

nr kat. **51.140**
H (mm) 260
L (mm) 75
grubość (mm) 2



NOWOŚĆ

nr kat. **51.141**
H (mm) 240
L (mm) 85
grubość (mm) 2



NOWOŚĆ

nr kat. **51.142**
H (mm) 240
L (mm) 85
grubość (mm) 2



NOWOŚĆ

nr kat. **51.143**
H (mm) 255
L (mm) 70
grubość (mm) 2



NOWOŚĆ

nr kat. **51.144**
H (mm) 235
L (mm) 85
grubość (mm) 2



nr kat. **51.200**
H (mm) 130
L (mm) 75
grubość (mm) 4



nr kat. **51.201**
H (mm) 190
L (mm) 125
grubość (mm) 5



nr kat. **51.202**
H (mm) 330
L (mm) 260
grubość (mm) 5



nr kat. **51.203**
H (mm) 210
L (mm) 120
grubość (mm) 5



nr kat. **51.204**
H (mm) 210
L (mm) 120
grubość (mm) 5



nr kat. **51.205**
H (mm) 183
L (mm) 173
grubość (mm) 2



nr kat. **51.206**
H (mm) 183
L (mm) 173
grubość (mm) 2



NOWOŚĆ

nr kat. **51.235**
Ø 160
grubość (mm) 2



NOWOŚĆ

nr kat. **51.236**
H (mm) 85
L (mm) 75
grubość (mm) 2



NOWOŚĆ

nr kat. **51.237**
H (mm) 170
L (mm) 70
grubość (mm) 2



NOWOŚĆ

nr kat. **51.238**
H (mm) 230
L (mm) 95
grubość (mm) 2



nr kat. 51.239 **NOWOŚĆ**
 H (mm) 250
 L (mm) 120
 grubość (mm) 2



nr kat. 51.240 **NOWOŚĆ**
 H (mm) 340
 L (mm) 210
 grubość (mm) 2

nr kat. 51.241 **NOWOŚĆ**
 H (mm) 340
 L (mm) 210
 grubość (mm) 2



nr kat. 51.300
 H (mm) 350
 L (mm) 70
 baza (mm) 16 x 8

nr kat. 51.301
 H (mm) 350
 L (mm) 70
 baza (mm) 16 x 8



nr kat. 51.302
 H (mm) 220
 L (mm) 130
 grubość (mm) 16 x 8

nr kat. 51.303
 H (mm) 220
 L (mm) 130
 grubość (mm) 16 x 8



nr kat. 51.400
 H (mm) 270
 L (mm) 110
 grubość (mm) 4

nr kat. 51.401
 H (mm) 270
 L (mm) 110
 grubość (mm) 4



nr kat. 51.410
 H (mm) 310
 L (mm) 100
 grubość (mm) 1,2



nr kat. 51.412
 H (mm) 450
 L (mm) 300
 grubość (mm) 1,5



nr kat. 51.411
 H (mm) 255
 L (mm) 230
 grubość (mm) 1,5



nr kat. 51.420
 H (mm) 146
 L (mm) 146
 grubość (mm) 1,5







nr kat. 51.421
 H (mm) 184
 L (mm) 184
 grubość (mm) 1,5



nr kat. 51.426
 H (mm) 410
 L (mm) 65
 grubość (mm) 1,5



nr kat. 51.425
 H (mm) 410
 L (mm) 65
 grubość (mm) 1,5

					
nr kat.	51.420	51.422	51.450	51.451	51.452
H (mm)	146	145	115	225	225
L (mm)	146	145	155	305	
grubość (mm)	1,5	1,5	1,5	2	2

zespoły ozdobne – staliwo

ornamental sets – cast steel / Dekorgruppen – Stahlguss / декоративные системы – литая сталь

						
nr kat.	52.001	52.002	52.003	52.004	52.005	52.006
H (mm)	85	85	105	105	270	270
L (mm)	70	70	95	95	110	110
grubość (mm)	4	4	3	3	4	4

						
nr kat.	52.007	52.008	52.009	52.010	52.011	52.012
H (mm)	260	260	140	140	150	150
L (mm)	135	135	65	65	130	130
grubość (mm)	4	4	4	4	4	4

						
nr kat.	52.013	52.014	52.015	52.016	52.017	52.018
H (mm)	140	140	190	190	155	155
L (mm)	110	110	160	160	140	140
grubość (mm)	4	4	4	4	4	4



nr kat.	52.019	52.020
H (mm)	250	250
L (mm)	150	150
grubość (mm)	4	4



nr kat.	52.021	52.022
H (mm)	220	220
L (mm)	105	105
grubość (mm)	4	4



nr kat.	52.023	52.024
H (mm)	180	180
L (mm)	85	85
grubość (mm)	4	4



nr kat.	52.025	52.026
H (mm)	165	165
L (mm)	105	105
grubość (mm)	4	4



nr kat.	52.027	52.028
H (mm)	200	200
L (mm)	125	125
grubość (mm)	4	4



nr kat.	52.029
H (mm)	215
L (mm)	140
grubość (mm)	4



nr kat.	52.030
H (mm)	170
L (mm)	75
grubość (mm)	4



nr kat.	52.031
H (mm)	220
L (mm)	180
grubość (mm)	4



nr kat.	52.032
H (mm)	185
L (mm)	80
grubość (mm)	4



nr kat.	52.033
H (mm)	245
L (mm)	125
grubość (mm)	4



nr kat.	52.034
H (mm)	235
L (mm)	105
grubość (mm)	4



nr kat.	52.035	52.036
H (mm)	225	225
L (mm)	130	130
grubość (mm)	4	4



nr kat.	52.037	52.038
H (mm)	155	155
L (mm)	55	55
grubość (mm)	4	4



nr kat.	52.039	52.040
H (mm)	230	230
L (mm)	65	65
grubość (mm)	4	4



nr kat.	52.041	52.042	52.043	52.044	52.045	52.046
H (mm)	150	150	115	190	175	155
L (mm)	55	55	55	60	50	90
grubość (mm)	4	4	4	4	4	4



nr kat.	52.047	52.048	52.049	52.050	52.051	52.052
H (mm)	135	160	240	240	170	170
L (mm)	75	45	150	150	138	138
grubość (mm)	4	4	4	4	4	4



nr kat.	52.130	52.131	52.132	52.133	52.134
H (mm)	160	60	90	90	135
L (mm)	160		8	5	
Ø (mm)		90	3		
otwór (mm)					
grubość (mm)	4	4			



nr kat.	52.135	52.136	52.137	52.139	52.201	52.202
H (mm)	85		92	55	125	155
L (mm)	80	100	78	4	75	110
Ø (mm)		3,5				
grubość (mm)	3		4	4	3	4



nr kat.	52.211	52.212	52.216	52.217	52.300	52.301	52.302
H (mm)	170	200	180	160			80
L (mm)	100	140	28	43			75
Ø (mm)			5	5	90	55	
grubość (mm)					8	8	1,5



nr kat.	52.303	52.304	52.305	52.306
H (mm)				85
L (mm)				70
Ø (mm)	100	70	90	
grubość (mm)	1,5	8	8	8



nr kat.	52.307	52.309	52.400	52.401	52.402	52.403
H (mm)	Ø 100	95	340	340	220	220
L (mm)		75	210	210	130	130
grubość (mm)	8	8	5	5	5	5



nr kat.	52.404
H (mm)	185
L (mm)	90
grubość (mm)	8



nr kat.	52.405
H (mm)	165
L (mm)	125
grubość (mm)	8



nr kat.	52.406
H (mm)	195
L (mm)	100
grubość (mm)	8



nr kat.	52.420
H (mm)	220
L (mm)	145
grubość (mm)	12

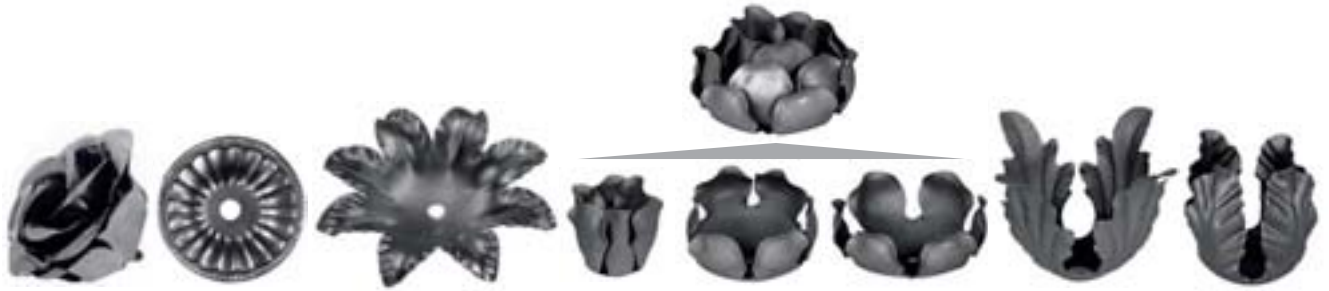

nr kat.	53.000	53.001	53.002	53.003	53.004	53.005	53.006	53.007
H (mm)		17	27	40	35	30	70	42
Ø (mm)	80	80	155	40	55	65	90	40
grubość (mm)	0,5	0,5	1	0,5	0,5	0,5	0,6	0,6



nr kat.	53.008	53.009	53.010	53.011	53.012	53.013
H (mm)	85	70	195	57	105	200
L (mm)	45	35	80	55	95	190
grubość (mm)	0,5	0,5	0,5	0,6	1	1



nr kat.	53.014	53.015	53.016	53.017	53.018	53.019
H (mm)	130	90	60	125	200	230
L (mm)	65	45	110	175	95	100
grubość (mm)	1	1	0,6	1	1	1

żeliwa

cast iron items / Gusseisen Waren / чугунные элементы

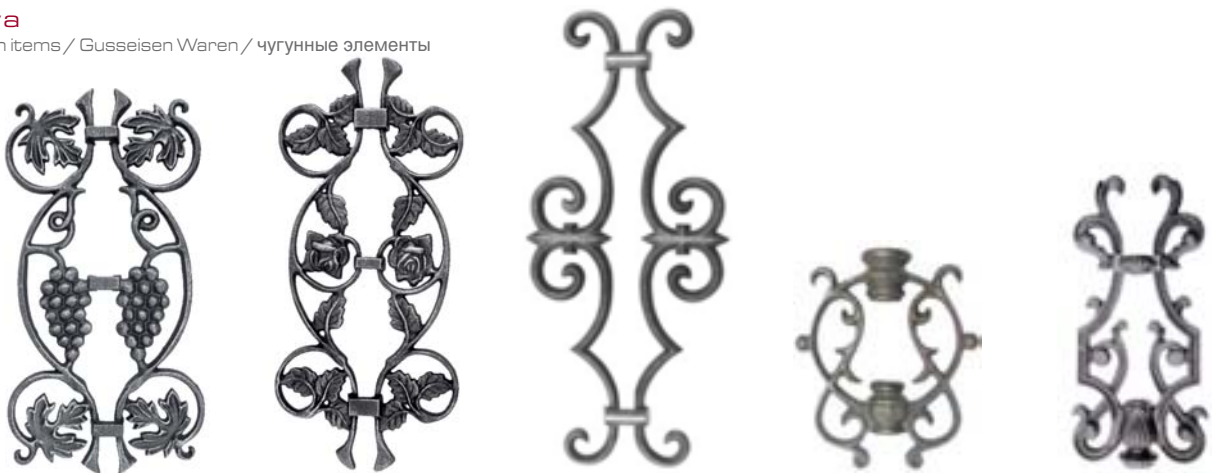

nr kat.	55.001	55.003	55.005	55.006	55.007
H (mm)	380	400	455	165	270
L (mm)	190	190	200	150	130
grubość (mm)	□ 14	□ 14	□ 14	□ 14	□ 14

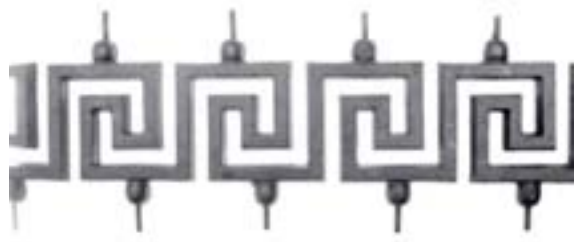

nr kat.

55.030

H (mm)

500

L (mm)

100

55.031

870

150

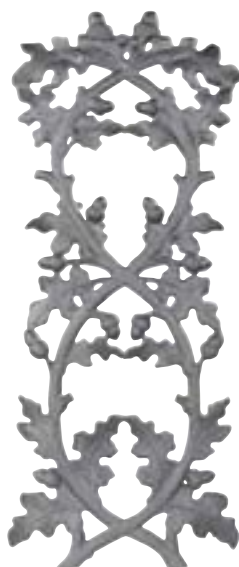
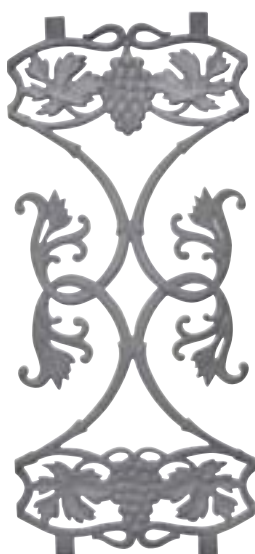

nr kat.

55.020

H (mm)

680

L (mm)

300

grubość (mm)

NOWOŚĆ

55.021

680

300

NOWOŚĆ

55.050

120

120

20



nr kat.

55.100

H (mm)

210

L (mm)

110

grubość (mm)

Ø 100

55.103

135

60

55.105

180

100

55.200

250

160

wózki i akcesoria cantilever gate carriages, accessories / Wagen, Zubehör / каретки, аксессуары



nr kat. 60.000
opis wózek jezdny 80 - rolki stalowe, duża płyta
nr kat. 60.000.01
opis wózek jezdny 80 - rolki tworzywo, duża płyta



nr kat. 60.001
opis wózek jezdny 80 - rolki stalowe
nr kat. 60.001.01
opis wózek jezdny 80 - rolki tworzywo



nr kat. 60.002
opis wózek jezdny 80 - rolki stalowe
nr kat. 60.002.01
opis wózek jezdny 80 - rolki tworzywo



nr kat. 60.003
opis wózek jezdny 80 - rolki stalowe
nr kat. 60.003.01
opis wózek jezdny 80 - rolki tworzywo



nr kat. 60.004
opis wózek jezdny 80 - rolki stalowe
nr kat. 60.004.01
opis wózek jezdny 80 - rolki tworzywo



nr kat. 60.005
opis wózek jezdny 80 - rolki stalowe
nr kat. 60.005.01
opis wózek jezdny 80 - rolki tworzywo



nr kat. 60.006
opis wózek jezdny 80 - rolki stalowe
nr kat. 60.006.01
opis wózek jezdny 80 - rolki tworzywo



nr kat. 60.007
opis wózek jezdny 80 - rolki stalowe
nr kat. 60.007.01
opis wózek jezdny 80 - rolki tworzywo



nr kat. 60.010
opis rolka najazdowa



nr kat. 60.020
opis uchwyt najazdu



nr kat. 60.021
opis uchwyt najazdu 80



nr kat. 60.022
opis uchwyt bramy 40, rolki gumowane



nr kat. 60.023
opis uchwyt bramy 60, rolki gumowane



nr kat. 60.024
opis uchwyt bramy 80, rolki gumowane



nr kat. 60.030
opis prowadzenie górne - stale
nr kat. 60.030.01
opis prowadzenie górne - regulowane



nr kat. 60.031
opis prowadzenie górne regulowane



nr kat. 60.040
opis rolka Ø 25 mm



nr kat. 60.040.01
opis rolka Ø 30 mm



nr kat. 60.040.02
opis rolka Ø 32 mm



nr kat. 60.040.03
opis rolka Ø 35 mm



nr kat. 60.040.05
opis rolka Ø 40 mm



nr kat. 60.043
opis rolka prowadząca



nr kat. 60.049
opis rolka Ø 40 mm, gumowana

listwy

strips / Leisten / планки



nr kat. 60.050
opis listwa zębata stalowa L 1000 x 10 mm

nr kat. 60.051
opis listwa zębata stalowa L 1000 x 8 mm



nr kat. 60.055
opis listwa zębata tworzywo L 1000 x 20 mm

rolki

rolls / Rollen / ролики



nr kat. 60.100
opis rolka jezdna „V” Ø 70 x 22 mm

nr kat. 60.101
opis rolka jezdna „V” Ø 90 x 22 mm



nr kat. 60.102
opis rolka jezdna „O” 1/2" Ø 70 mm

nr kat. 60.103
opis rolka jezdna „O” 1/2" Ø 90 mm



nr kat. 60.103.01
opis rolka jezdna „O” 3/4" Ø 90 mm



nr kat. 60.104
opis rolka jezdna „T” Ø 70 x 22 mm

nr kat. 60.105
opis rolka jezdna „T” Ø 90 x 22 mm



nr kat. 60.106
opis rolka jezdna „V” Ø 75 x 22 mm

nr kat. 60.107
opis rolka jezdna „V” Ø 90 x 22 mm



nr kat. 60.108
opis rolka jezdna „O” 1/2" Ø 75 mm

nr kat. 60.109
opis rolka jezdna „O” 1/2" Ø 90 mm



nr kat. 60.109.01
opis rolka jezdna „O” 3/4" Ø 90 mm



nr kat. 60.110
opis rolka jezdna „T” Ø 75 x 22 mm

nr kat. 60.111
opis rolka jezdna „T” Ø 90 x 22 mm

zawiasy

hinges / Scharniere / петли



nr kat. 61.000
opis zawias regulowany M20
100 x 100 x 4 mm



nowość
nr kat. 61.010
opis zawias M18 do spawania



nowość
nr kat. 61.011
opis zawias M22 do spawania



nr kat. 61.018
opis zawias regulowany M16
80 x 80 x 3 mm



nr kat.
opis

61.021
zawias regulowany
M20 do spawania



61.023
zawias regulowany
M18 do spawania



61.024
zawias regulowany
M22 do spawania



61.027
zawias M20
do spawania



nr kat.
opis

61.028
zawias M24 do spawania



61.029
zawias M18 do spawania



61.030
zawias M22 do spawania



61.040
zawias M20 do wmurowania



nr kat.
opis

61.041
zawias M24 do wmurowania



61.042
zawias M18 do wmurowania



61.043
zawias M22 do wmurowania



nr kat.
opis

61.051
zawias M16 kąt.
otwarcia 180°

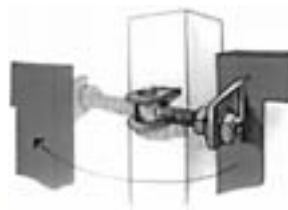

zastosowanie 61.051 i 61.052

61.052
zawias M20 kąt.
otwarcia 180°



61.090
stoper do bramy
dwuskrzydłowej



61.091
stoper do bramy dwuskrzydłowej
do przykręcenia

nr kat.
opis

61.095
ogrodzeniowa listwa antywłamaniowa

H (mm) 33
L (mm) 2000
grubość (mm) 3



nr kat.	61.100	61.101	61.102	61.103	61.104	61.105
H (mm)	100	130	100	122	146	230
L (mm)	20	29	20	24	30	30



nr kat.	61.106	61.107	61.112	61.116	61.120	61.124	61.127.01	61.130.01	61.135.01	61.140.01
H (mm)	145	190	H 60, Ø 12	H 66, Ø 16	H 70, Ø 20	H 80, Ø 24	H 90, Ø 27	H 100, Ø 30	H 120, Ø 35	H 120, Ø 40
opis	zawias ozdobny z kulą	zawias ozdobny z kulą	zawias toczony	zawias toczony	zawias toczony	zawias toczony	zawias toczony	zawias toczony	zawias toczony	zawias toczony



nr kat.	61.202	61.211	61.212	61.221	61.222
baza (mm)	H 210 x L 90 Ø 27	H 400 x L 50 Ø 27	H 400 x L 50 Ø 27	H 400 x L 650 □ 50 x 5	H 250 x L 290 □ 35 x 4

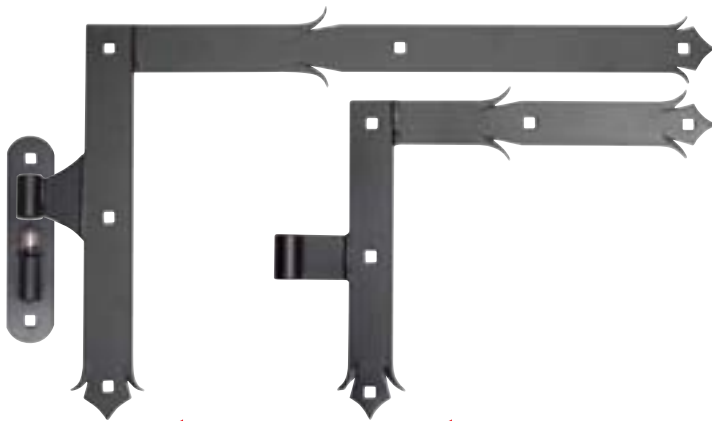

nr kat. **61.223**
baza (mm) H 400 x L 650
□ 50 x 5

nr kat. **61.224**
H 250 x L 290
□ 35 x 4



nr kat. **61.231**
L 220
Ø 27

nr kat. **61.232**
L 240
Ø 35

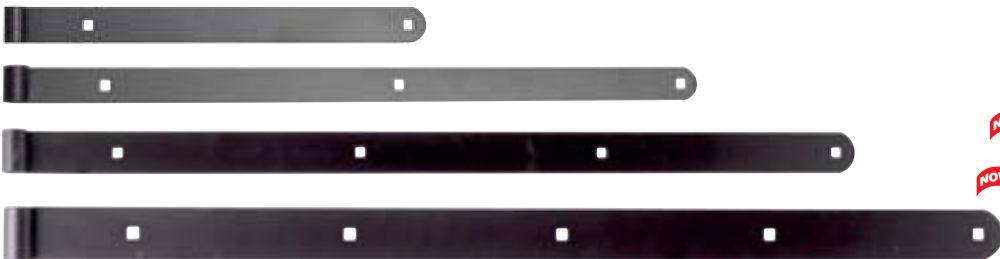

nr kat. **61.251** H 400 x L 35

nr kat. **61.252** H 600 x L 35

nr kat. **61.253** H 800 x L 40

nr kat. **61.254** H 1000 x L 50

nr kat. **61.255** H 1200 x L 60



nr kat. **61.256** H 500 x L 35

nr kat. **61.257** H 700 x L 50



nr kat. **61.261**
baza (mm) H 150 x L 35
Ø 14

nr kat. **61.262**
H 200 x L 40
Ø 18

nr kat. **61.263**
H 220 x L 50
Ø 18

nr kat. **61.264**
H 220 x L 60
Ø 20

nr kat. **61.265**
H 150 x L 35
Ø 14



nr kat. **61.271**
H 150 x L 35
Ø 14

nr kat. **61.272**
H 200 x L 40
Ø 18

nr kat. **61.273**
H 220 x L 50
Ø 18

nr kat. **61.274**
H 270 x L 60
Ø 20

daszki

post tops / Deckel / навесы



nr kat.	62.003	62.004	62.005	62.006	62.008	62.010	62.012	62.015	62.020
□ (mm)	30	40	50	60	80	100	120	150	200
H (mm)	1,5	1,5	1,5	1,5	1,5	1,5	1,5	1,5	1,5



nr kat.	62.004.04	62.006.06	62.008.06	62.010.06	62.012.10
opis	40 x 40 mm / kula Ø 40 mm	60 x 60 mm / kula Ø 60 mm	80 x 80 mm / kula Ø 60 mm	100 x 100 mm / kula Ø 60 mm	120 x 120 mm / kula Ø 100 mm
nr kat.	62.005.05	62.006.08	62.008.08	62.010.08	62.012.12
opis	50 x 50 mm / kula Ø 50 mm	60 x 60 mm / kula Ø 80 mm	80 x 80 mm / kula Ø 80 mm	100 x 100 mm / kula Ø 80 mm	120 x 120 mm / kula Ø 120 mm
nr kat.	62.005.06	62.007.06	62.009.08	62.010.10	
opis	50 x 50 mm / kula Ø 60 mm	70 x 70 mm / kula Ø 60 mm	90 x 90 mm / kula Ø 80 mm	100 x 100 mm / kula Ø 100 mm	
nr kat.	62.006.05	62.007.07	62.009.09	62.012.08	
opis	60 x 60 mm / kula Ø 50 mm	70 x 70 mm / kula Ø 70 mm	90 x 90 mm / kula Ø 90 mm	120 x 120 mm / kula Ø 80 mm	



nr kat.	62.031	62.032	62.033	62.034	62.035	62.036
Ø (mm)	Ø 42 [5/4"]	Ø 48 [1,5"]	Ø 60 [2"]	Ø 77	Ø 90	Ø 100
grubość (mm)	1,5	1,5	1,5	1,5	1,5	1,5



nr kat.	62.042	62.048	62.060	62.072	62.077	62.080	62.090	62.100
Ø (mm)	42 [5/4"]	48 [1,5"]	60 [2"]	72	77	80	90	100
grubość (mm)	1,5	1,5	1,5	1,5	1,5	1,5	1,5	1,5



nr kat.	62.042.06	62.060.08	62.077.08	62.090.09
opis	Ø 42 mm [5/4"] / kula Ø 60 mm	Ø 60 mm [2"] / kula Ø 80 mm	Ø 77 mm / kula Ø 80 mm	Ø 90 mm / kula Ø 90 mm
nr kat.	62.048.06	62.072.08	62.080.06	62.100.08
opis	Ø 48 mm [1,5"] / kula Ø 60 mm	Ø 72 mm / kula Ø 80 mm	Ø 80 mm / kula Ø 60 mm	Ø 100 mm / kula Ø 80 mm
nr kat.	62.060.06	62.077.06	62.080.08	62.100.10
opis	Ø 60 mm [2"] / kula Ø 60 mm	Ø 77 mm / kula Ø 60 mm	Ø 80 mm / kula Ø 80 mm	Ø 100 mm / kula Ø 100 mm

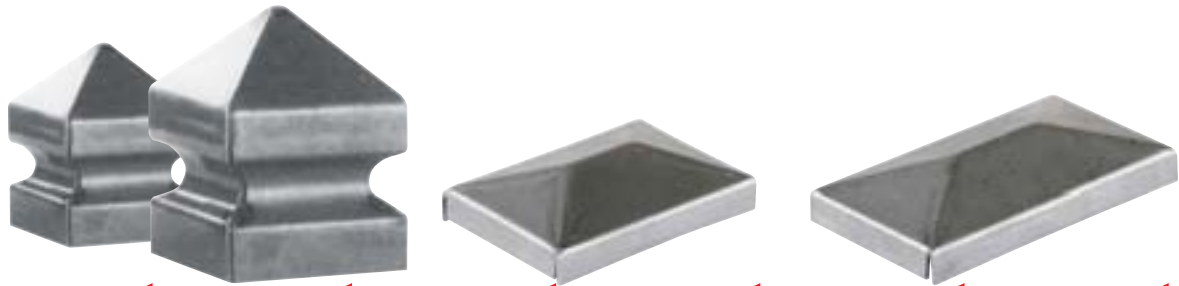

nr kat.	62.106	62.110	62.123	62.134	62.136	62.148
□ (mm)	60 x 60	100 x 100	20 x 30	30 x 40	30 x 60	40 x 80
H (mm)	90	140	1,5	1,5	1,5	1,5
nr kat.	62.108		62.124	62.135	62.146	62.151
□ (mm)	80 x 80		20 x 40	30 x 50	40 x 60	50 x 100
H (mm)	120		1,5	1,5	1,5	1,5

zaśleпки

stoppers / Verschlusskappen / заглушки



nr kat.	62.200 NOWOŚĆ	62.202	62.204	62.207	62.209	62.211 NOWOŚĆ	62.213
□ (mm)	15	20	30	40	50	70	100
nr kat.	62.201 NOWOŚĆ	62.203	62.206 NOWOŚĆ	62.208 NOWOŚĆ	62.210	62.212	62.214
□ (mm)	16	25	35	45	60	80	120



nr kat.	62.220 NOWOŚĆ	62.223	62.227	62.230	62.233 NOWOŚĆ	62.236 NOWOŚĆ
□ (mm)	10 x 20	20 x 30	27 x 40	40 x 60	50 x 80	60 x 100
nr kat.	62.221 NOWOŚĆ	62.224	62.228	62.231	62.234 NOWOŚĆ	62.237 NOWOŚĆ
□ (mm)	15 x 25	20 x 40	30 x 50	40 x 80	50 x 100	60 x 120
nr kat.	62.222 NOWOŚĆ	62.226 NOWOŚĆ	62.229	62.232 NOWOŚĆ	62.235 NOWOŚĆ	
□ (mm)	18 x 30	25 x 40	30 x 60	40 x 100	60 x 80	



nr kat.	62.240	62.243	62.246	62.249	62.252 NOWOŚĆ	62.259 NOWOŚĆ	62.262
Ø (mm)	16	25	35	50	76	1"	2"
nr kat.	62.241	62.244	62.247	62.250 NOWOŚĆ	62.257 NOWOŚĆ	62.260	62.263
Ø (mm)	18	30	40	60	1/2"	1 1/4"	2 1/2"
nr kat.	62.242	62.245	62.248	62.251 NOWOŚĆ	62.258 NOWOŚĆ	62.261	
Ø (mm)	20	32	43	70	3/4"	1 1/2"	



nr kat.	62.272	62.273	62.274	62.294	62.303	62.304	62.346
opis	Ø 20 mm	Ø 25 mm	Ø 28 mm	Ø 1 1/2"	Ø 1 1/4"	Ø 1 1/2"	40 x 60

maskownice do śrub

screw caps / Blenden für Schrauben / маскировочные элементы для болтов



nr kat.	62.406	62.408	62.410	62.412	62.414	62.416
opis	M6	M8	M10	M12	M14	M16

klamki kute

forged door handles / geschmiedete Griffe / кованные ручки



nr kat.	63.001	63.003	63.004
H (mm)	135	155	135
L (mm)	75	95	75



nr kat.	63.005	63.006	63.007
H (mm)	160	140	135
L (mm)	85	75	75



nr kat. **63.012**
H (mm) 137
L (mm) 75



nr kat. **63.013**
H (mm) 142
L (mm) 90



nr kat. **63.014**
H (mm) 121
L (mm) 95



nr kat. **63.002**
H (mm) 60
L (mm)



nr kat. **63.008**
H (mm) 85
L (mm) 65



nr kat. **63.009**
H (mm) 70
L (mm) 65



nr kat. **63.010**
H (mm) 65
L (mm) 65



nr kat. **63.011**
H (mm) 55
L (mm) 65



nr kat. **63.015**
H (mm) 70
L (mm) 116



nr kat. **63.016**
H (mm) 90
L (mm) 116



nr kat. **63.017**
H (mm) 60
L (mm) 70



nr kat. **63.018**
H (mm) 60
L (mm) 70



nr kat. **63.020**
H (mm) 145
L (mm) 110
pręt - Ø 12 mm



nr kat. **63.024**
H (mm) 280
L (mm) 90



nr kat. **63.025**
H (mm) 380
L (mm) 70



nr kat. **63.026**
H (mm) 460
L (mm) 110



nowość

nr kat. **63.027**
H (mm) 85
L (mm) Ø 68



nowość

nr kat. **63.028**
H (mm) 110
L (mm) Ø 68



nowość

nr kat. **63.029**
H (mm) 155



nowość

nr kat. **63.030**
H (mm) 125

szylidy (otwory w rozstawie 90 mm)

escutcheons (spacing of openings – 90 mm) / Schilder (Abstand zwischen den Öffnungen 90 mm) / накладки (отверстия с шагом 90 мм)



63.101

nr kat. **63.101**
H (mm) 275
L (mm) 130
grubość (mm) 3



63.102

nr kat. **63.102**
H (mm) 275
L (mm) 130
grubość (mm) 3



63.103

nr kat. **63.103**
H (mm) 275
L (mm) 130
grubość (mm) 3



63.102.01

nr kat. **63.102.01**
H (mm) 275
L (mm) 130
grubość (mm) 3



63.103.01

nr kat. **63.103.01**
H (mm) 275
L (mm) 130
grubość (mm) 3



63.104

nr kat. **63.104**
H (mm) 290
L (mm) 160
grubość (mm) 4

63.105

nr kat. **63.105**
H (mm) 290
L (mm) 160
grubość (mm) 4



63.106

nr kat. **63.106**
H (mm) 290
L (mm) 160
grubość (mm) 4



63.107

nr kat. **63.107**
H (mm) 290
L (mm) 160
grubość (mm) 4



63.108

nr kat. **63.108**
H (mm) 305
L (mm) 135
grubość (mm) 4



63.109

nr kat. **63.109**
H (mm) 305
L (mm) 135
grubość (mm) 4



63.110

nr kat. **63.110**
H (mm) 305
L (mm) 135
grubość (mm) 4



63.111

nr kat. **63.111**
H (mm) 295
L (mm) 90
grubość (mm) 4



63.112

nr kat. **63.112**
H (mm) 295
L (mm) 90
grubość (mm) 4

63.113

nr kat. **63.113**
H (mm) 295
L (mm) 90
grubość (mm) 4



63.114

nr kat. **63.114**
H (mm) 295
L (mm) 120
grubość (mm) 3



63.115

nr kat. **63.115**
H (mm) 295
L (mm) 120
grubość (mm) 3



63.116

nr kat. **63.116**
H (mm) 295
L (mm) 120
grubość (mm) 3



63.117

nr kat. **63.117**
H (mm) 275
L (mm) 160
grubość (mm) 3



63.118

nr kat. **63.118**
H (mm) 275
L (mm) 160
grubość (mm) 3



63.119

nr kat. **63.119**
H (mm) 275
L (mm) 160
grubość (mm) 3

63.120

nr kat. **63.120**
H (mm) 275
L (mm) 160
grubość (mm) 3



nr kat.	63.119.01	63.120.01	63.121	63.122	63.123	63.124
H (mm)	275	275	330	330	330	330
L (mm)	160	160	180	180	180	180
grubość (mm)	3	3	5	5	5	5























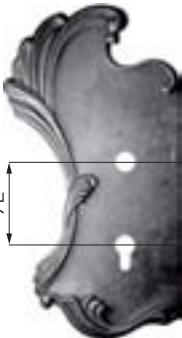

nr kat.	63.125	63.126	63.127	63.128	63.129	63.130	63.131
H (mm)	270	270	270	270	280	280	280
L (mm)	165	165	165	165	100	100	100
grubość (mm)	3	3	3	3	3	3	3

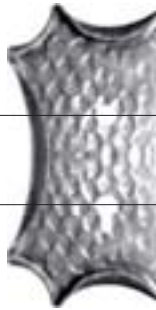
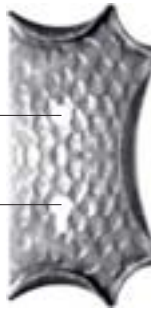

nr kat.	63.130.01	63.131.01	63.133	63.134	63.135	63.136	63.137
H (mm)	280	280	230	290	290	290	290
L (mm)	100	100	40	160	160	160	160
grubość (mm)	3	3	5	2,5	2,5	2,5	2,5



nr kat.	63.136.01	63.137.01	63.138	63.139	63.140	63.141
H (mm)	290	290	260	260	260	260
L (mm)	160	160	57	52	46	56
grubość (mm)	2,5	2,5	4	4	4	4

							
nr kat.	63.142	63.143	63.144	63.145	63.146	63.147	63.148
H (mm)	130	130	Ø 50	Ø 50	315	330	330
L (mm)	36	36			135	175	175
							
nr kat.	63.149	63.150	63.151	63.152	63.153	63.154	
H (mm)	315	315	330	330	330	330	
L (mm)	135	135	175	175	175	175	
							
nr kat.	63.155	63.156	63.157	63.158	63.159	63.160	63.161
H (mm)	330	330	280	280	280	280	280
L (mm)	175	175	140	140	140	140	140
							
nr kat.	63.171	63.172	63.173	63.174	63.175	63.176	
H (mm)	285	285	290	290	277	277	
L (mm)	155	155	160	160	104	104	
grubość (mm)	2,5	2,5	2,5	2,5	3	3	



	NOWOŚĆ	NOWOŚĆ
nr kat.	63.177	63.178
H (mm)	295	295
L (mm)	135	135
grubość (mm)	3,7	3,7

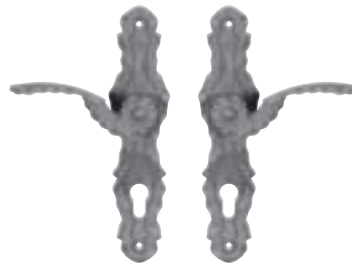

	NOWOŚĆ	NOWOŚĆ
nr kat.	63.191	63.192
H (mm)	260	260
L (mm)	57	57
grubość (mm)	4	4

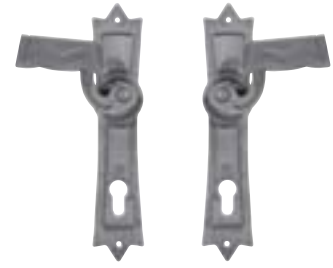

	NOWOŚĆ	NOWOŚĆ
nr kat.	63.193	63.194
H (mm)	260	260
L (mm)	52	52
grubość (mm)	4	4

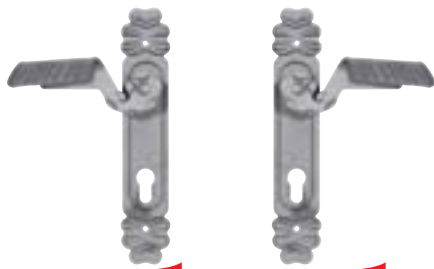

	NOWOŚĆ	NOWOŚĆ
nr kat.	63.195	63.196
H (mm)	260	260
L (mm)	46	46
grubość (mm)	4	4

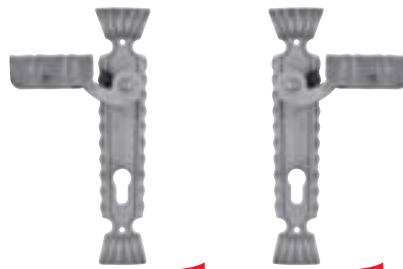

	NOWOŚĆ	NOWOŚĆ
nr kat.	63.197	63.198
H (mm)	260	260
L (mm)	56	56
grubość (mm)	4	4



zamki

locks / Türschlösser / замки

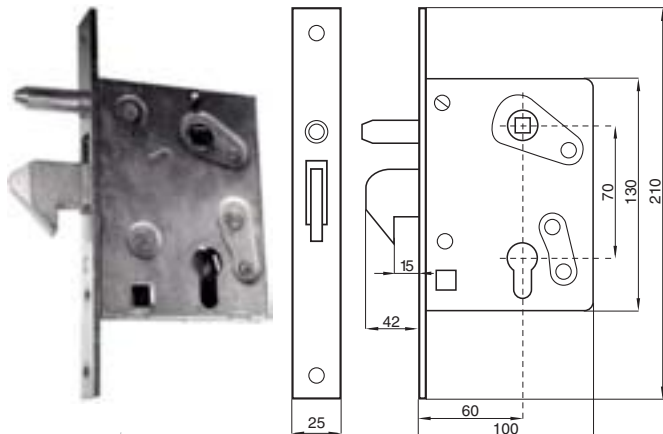

nr kat.
opis

63.200
zamek hakowy 60 z blachą czołową



63.202
obudowa zamka 63.200 L=40

63.203
obudowa zamka 63.200 L=50

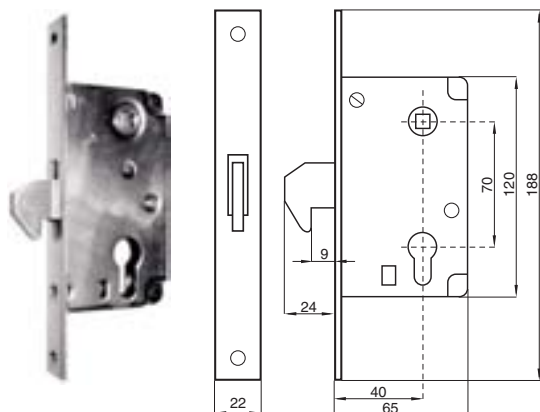

nr kat.
opis

63.204
zamek hakowy 40 z blachą czołową

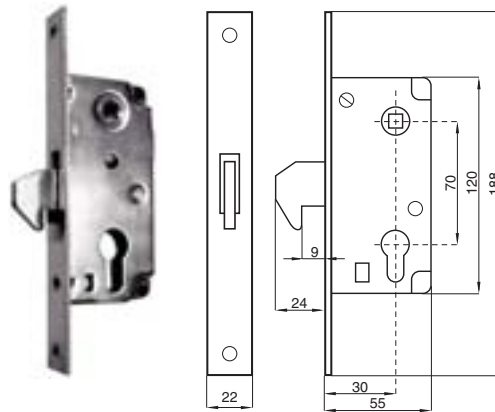

63.205
zamek hakowy 30 z blachą czołową



nr kat.
opis

63.207
zamek wąski 20

rozmiary
A 20,0 B 33,5

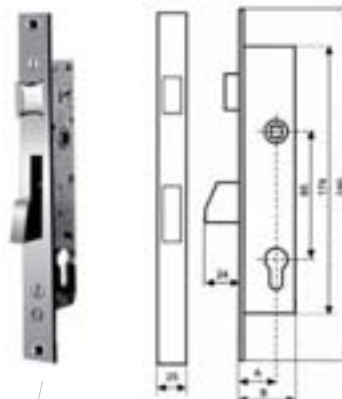

63.208
zamek wąski 20 na klamkę

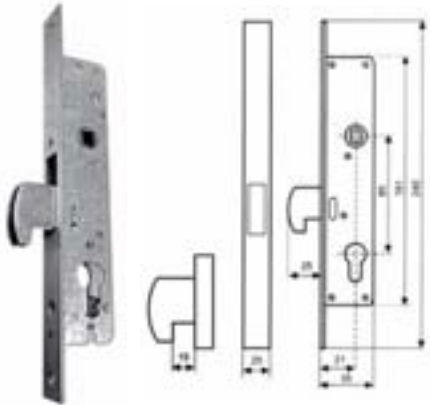

nr kat.
opis

63.209
zamek hakowy wzmacniony 21

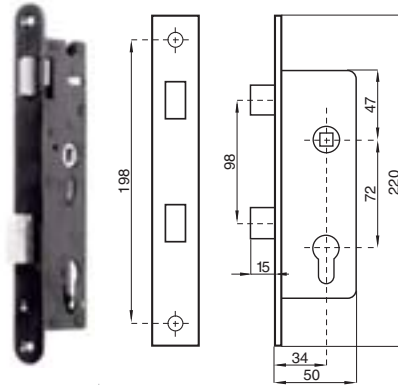

63.211
H 220 mm



nr kat.
H [mm]

63.212
220



63.213
140



63.214
140



63.215
100



nr kat.
H (mm)
L (mm)
opis

63.220
245
50 x 30



63.220.11
245
50 x 30
63.220 + 63.211



63.220.12
245
50 x 30
63.220 + 63.212



nr kat.	63.221	63.221.13	63.221.14	63.222	63.222.11	63.222.12
H (mm)	165	165	165	245	245	245
L (mm)	50 x 30	50 x 30	50 x 30	60 x 40	60 x 40	60 x 40
opis		63.223 + 63.213	63.223 + 63.214		63.222 + 63.211	63.222 + 63.212



nr kat.	63.223	63.223.13	63.223.14	63.225
H (mm)	165	165	165	200
L (mm)	60 x 40	60 x 40	60 x 40	40
opis		63.223 + 63.213	63.223 + 63.214	

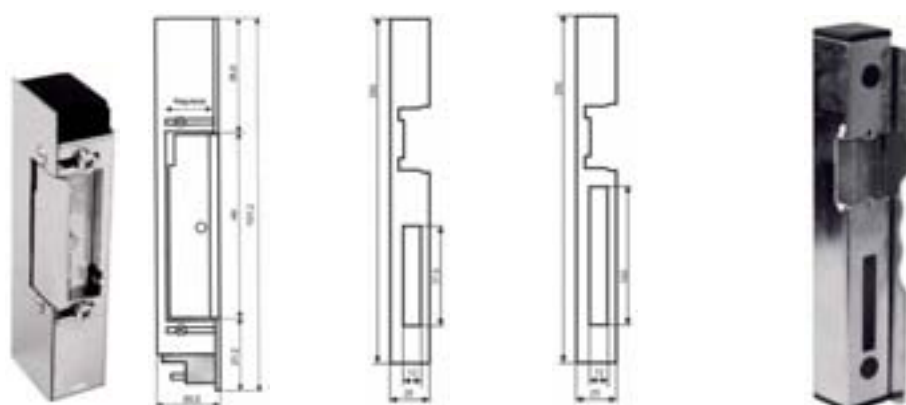

nr kat.	63.330	63.330.01	63.330.02	63.331
opis	elektrozaczep - 12 AC	blacha czołowa elektrozaczepu		H 280 mm

wkładki

lock inserts / Schlosskästen / вкладыши



nr kat.	63.300.01	63.300.07	63.300.12	63.301.01	63.301.02	63.301.05
opis	wkładka patentowa	wkładka patentowa	wkładka patentowa	wkładka FC	wkładka FC, nikiel	wkładka FC
wymiary (mm)	30 x 30	35 x 35	40 x 40	27 x 27	27 x 27	30 x 30



nr kat.	63.301.06	63.301.11	63.301.12	63.301.19	63.301.20
opis	wkładka FC, nikiel	wkładka FC	wkładka FC, nikiel	wkładka FC	wkładka FC, nikiel
wymiary (mm)	30 x 30	35 x 35	35 x 35	40 x 40	40 x 40

mocowania

fixings / Aufnahmen / крепления



nr kat.	64.001	64.002	64.010	64.011	64.012
H (mm)	130	180	420	180	180
L (mm)	60	80	210	95	95
baza (mm)			□20	□12	□12
grubość (mm)	10	10			

nity

rivets / Niete / заклепки



nr kat.	64.020	64.021	64.022	64.023
Ø (mm)	6	6	6	10
wymiary (mm)	H 40 x Ø 19	H 25 x Ø 25	H 36 x Ø 18	H 32 x Ø 21

łańcuchy ozdobne

decorative chains / Zierketten / декоративные цепи



nr kat.	64.031	64.032	64.033
H (mm)	2000	2000	2000
przekrój (mm)	6x6	6x6	6x6

zasuwki i rygle

bolts and locks / Schieber und Riegel / щеколды и засовы



nr kat.	64.050	64.051	64.052
wymiary (mm)	L 150	L 270	L 340
Ø (mm)	12	16	16

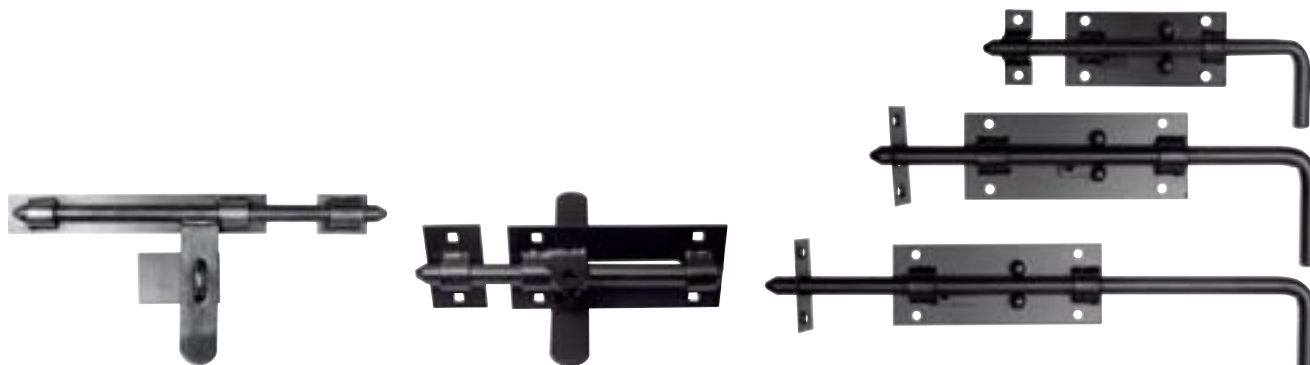

nr kat.	64.053	64.054	64.055	64.060	64.061	64.062
wymiary (mm)	L 340	L 340	L 210	L 220	L 320	L 420
Ø (mm)	16	16 ocynkowana	14	12	14	14

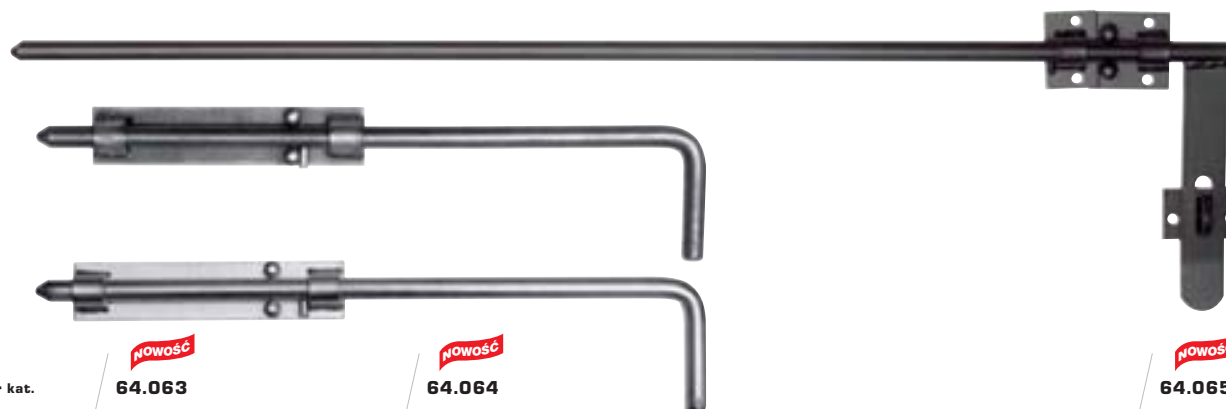

nr kat.	64.063	64.064	64.065
wymiary (mm)	L 420	L 420	L 800
Ø (mm)	14	14 ocynkowany	14

cyfry i litery

digits and letters / Buchstaben und Zahlzeichen / цифры и буквы



nr kat.	64.100	64.101	64.102	64.103	64.104	64.105	64.106
H (mm)	120	120	120	120	120	120	120
nr kat.	64.100.01	64.101.01	64.102.01	64.103.01	64.104.01	64.105.01	64.106.01
H (mm)	170 NOWOŚĆ	170 NOWOŚĆ	170 NOWOŚĆ	170 NOWOŚĆ	170 NOWOŚĆ	170 NOWOŚĆ	170 NOWOŚĆ



nr kat.	64.107	64.108	64.109	64.110	64.111	64.112	64.113
H (mm)	120	120	120	120	120	120	120
nr kat.	64.107.01	64.108.01	64.109.01				
H (mm)	170 NOWOŚĆ	170 NOWOŚĆ	170 NOWOŚĆ				



nr kat.	64.110.01	64.111.01	64.112.01	64.113.01
H (mm)	170	170	170	170



nr kat.	64.501
wymiary szyldu (mm)	130x115



nr kat.	64.502
wymiary szyldu (mm)	130x115



nr kat.	64.503
wymiary szyldu (mm)	155x140

wskaźniki wiatru

weathervanes / Wetterfahnen / флюгера



nr kat.
65.001
H (mm)
1400



nr kat.
65.002
H (mm)
1200



nr kat.
65.003
H (mm)
1400



nr kat.
65.004
H (mm)
1000

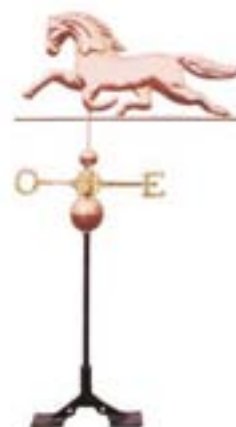

skrzynki pocztowe

letter boxes / Briefkästen / почтовые ящики



nr kat.
65.200
H (mm)
405
L (mm)
255
głębokość (mm)
90



nr kat.
65.201
H (mm)
405
L (mm)
255
głębokość (mm)
90



nr kat.
65.202
H (mm)
405
L (mm)
255
głębokość (mm)
90



nr kat.

65.210

H (mm)

445

L (mm)

395

głębokość (mm)

170



65.211

445

395

170



nr kat.

65.250

H (mm)

370

L (mm)

360

głębokość (mm)

132



65.251

370

360

132



65.255

370

360

132

lampy

lamps / Lampen / лампа



nr kat.

66.001

wymiary (mm)

Ø 290 x H 350

nr kat.

wymiary (mm)



66.002

H 530 x L 290 x 330



66.003 – malowana

H 670 x L 310 x 420

66.003.01 – ocynkowana

H 670 x L 310 x 420

NOWOŚĆ



nr kat. **66.004** – malowana
 wymiary (mm) H 400 x L 300
 nr kat. **66.004.01** – ocynkowana **NOWOŚĆ**
 wymiary (mm) H 400 x L 300



kinkiet

66.005 – malowana **NOWOŚĆ**
 H 460 x L 240 x 150
66.005.01 – ocynkowana **NOWOŚĆ**
 H 460 x L 240 x 150



66.006 – malowana **NOWOŚĆ**
 H 380 x L 290
66.006.01 – ocynkowana **NOWOŚĆ**
 H 380 x L 290

zestawy kominkowe

fireplace sets / Kaminsätze / каминные системы



nr kat. **66.100** **NOWOŚĆ**
 H (mm) 840



66.101 **NOWOŚĆ**
 810



66.102 **NOWOŚĆ**
 580



nr kat. **66.103** **NOWOŚĆ**
 H (mm) 665



66.104 **NOWOŚĆ**
 670

farby

paints / Farben / краски

Przeznaczone do malowania powierzchni stalowych, stalowych ocynkowanych, żeliwnych, dla ochrony antykorozyjnej i w celach dekoracyjnych.

Zalecane do malowania bram, ogrodzeń, krat, balustrad i innych wyrobów z kutej stali.

Tworzą wysokiej jakości powłokę kryjącą, półmatową, o bardzo dobrej przyczepności do podłoża i dużej elastyczności.

Charakterystyczny metaliczny wygląd nadaje powierzchni strukturę wypięskowanego metalu.

Farby można stosować na zewnątrz i wewnątrz pomieszczeń – posiadają wysoką odporność na czynniki atmosferyczne.



grafit antyczny

70.001

poj. 0,8 l

70.001.01

poj. 3 l



czarny antyczny

70.002

poj. 0,8 l

70.002.01

poj. 3 l



brąz antyczny

NOWOŚĆ

70.003

poj. 0,8 l

NOWOŚĆ

70.003.01

poj. 3 l

patyny

patina paints / Edelrost / патины

Przeznaczone do dekorowania wyrobów ze stali. Mogą być stosowane na zewnątrz jak i wewnątrz pomieszczeń.



patyna złoto



70.101

poj. 0,23 l



patyna srebro



70.102

poj. 0,23 l



patyna miedź



70.103

poj. 0,23 l



patyna zieleń



70.104

poj. 0,23 l

automatyka bram

gate automation systems / Torautomatik / автоматика для ворот



C001

zestaw do bramy przesuwnej o masie do 400 kg „BX PLUS”

silownik 1 szt.
płyta sterująca 1 szt.
karta częstotliwości 1 szt.
pilot 2-kanalowy 1 szt.
fotokomórki 1 kpl.



C002

zestaw do bramy przesuwnej o masie do 800 kg „BX STRONG”

silownik 1 szt.
płyta sterująca 1 szt.
karta częstotliwości 1 szt.
pilot 2-kanalowy 1 szt.
fotokomórki 1 kpl.



C010

zestaw do bram dwuskrzydłowych o długości skrzydła do 3 m „KRONO STANDARD”

silownik 2 szt.
płyta sterująca 1 szt.
obudowa płyty sterującej 1 szt.

karta częstotliwości 1 szt.
pilot 2-kanalowy 1 szt.
fotokomórki 1 kpl.



C020

zestaw z silownikami podziemnymi do bram 2-skrzydłowych o długości 1 skrzydła do 3,5 m „FROG 230V”

silownik podziemny 230V FROG A 2 szt.
obudowa silownika FROG B 2 szt.
zamek wysprzęgający A4364 2 szt.
płyta sterująca 1 szt.

obudowa płyty sterującej 1 szt.
karta częstotliwości 1 szt.
pilot 2-kanalowy 1 szt.
fotokomórki 1 kpl.



C025

zestaw z silownikami ATI do bram 2-skrzydłowych o długości skrzydła do 3 m

silownik 2 szt.
płyta sterująca 1 szt.
obudowa płyty sterującej 1 szt.

karta częstotliwości 1 szt.
pilot 2-kanalowy 1 szt.
fotokomórki 1 kpl.



nr kat.
opis

C100

pilot 2-kanałowy
na kod zmienny „SP2”



C101

pilot 4-kanałowy
na kod zmienny „SP4”



C110

lampa ostrzegawcza
230 V, 25 W „KIARON”



C111

antena na 433,92 MHz
„TOP - A433”



nr kat.
opis

C202

automat do bram garażowych
„VER - 900” - 130 W



C201

automat do bram garażowych
„VER - 700” - 260 W

siłownik 24 V 1 szt.
karta częstotliwości 1 szt.
pilot 2-kanałowy 1 szt.
bez szyny!

siłownik 24 V 1 szt.
karta częstotliwości 1 szt.
pilot 2-kanałowy 1 szt.
bez szyny!



nr kat.
opis

C210

szyna transmisyjna z łańcuchem
długości 3.02 m „V0679”

do bram garażowych
uchyłnych do 2,4 m
do bram segmentowych
do 2,25 m



C211

szyna transmisyjna z łańcuchem
długości 3.52 m „V0682”

do bram garażowych
uchyłnych do 2,9 m
do bram segmentowych
do 2,75 m

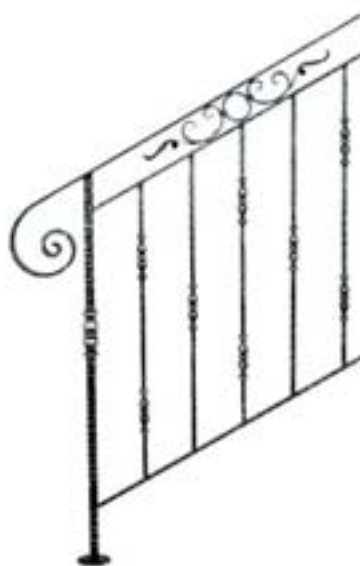
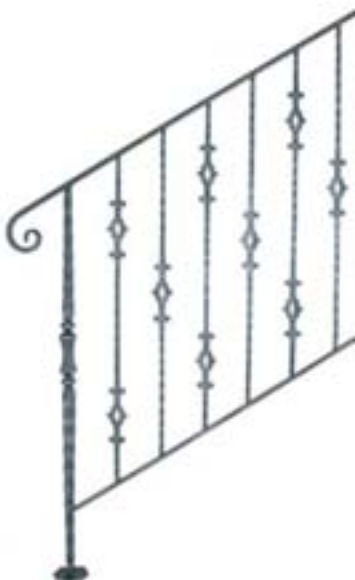

POŁĘCZE

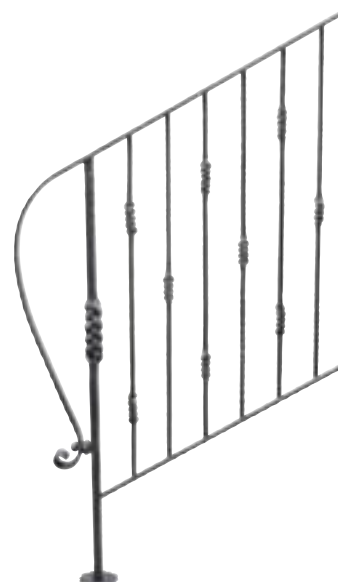

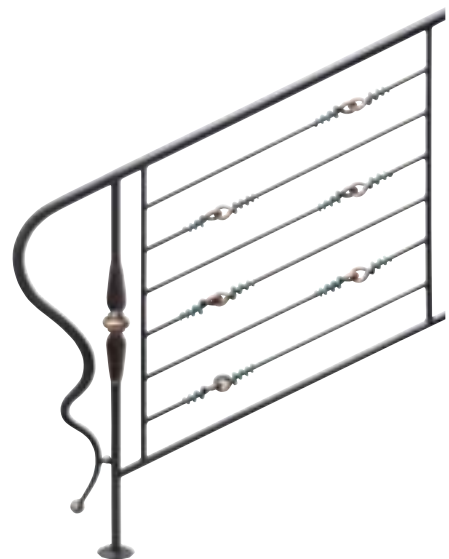
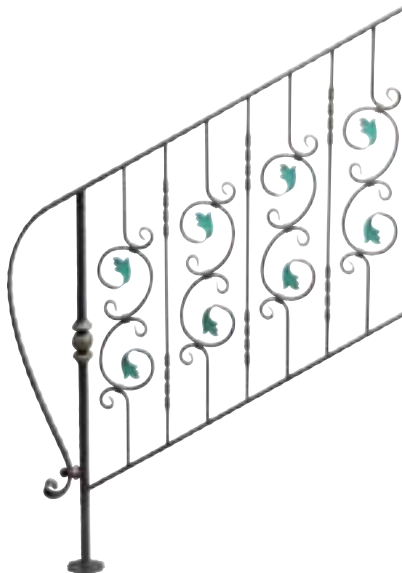

PORECZE

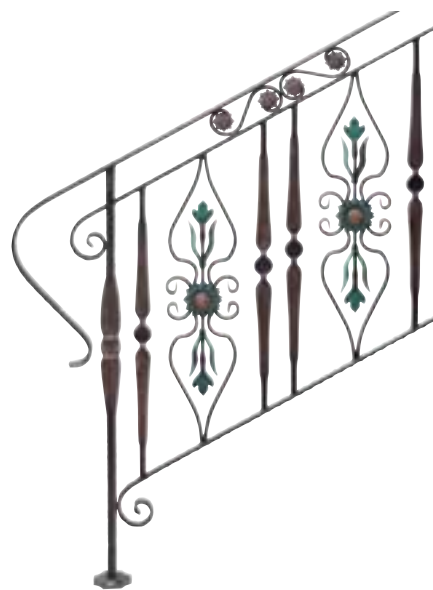
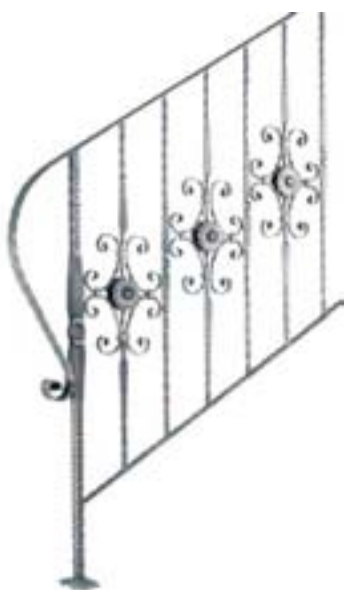



kraty

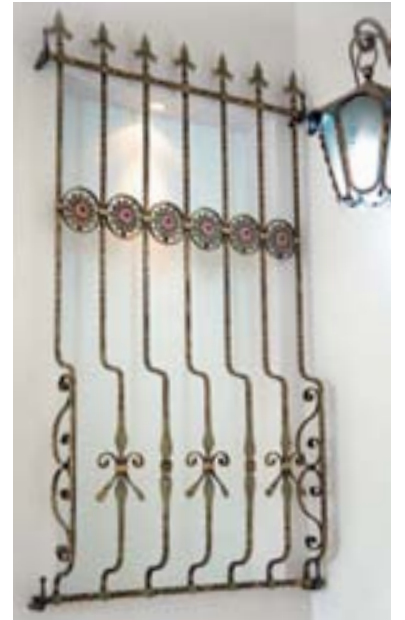



balustrady





ogrodzenie





ogrodzenie

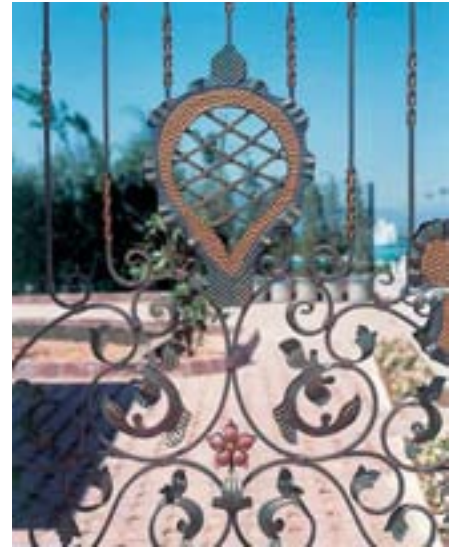

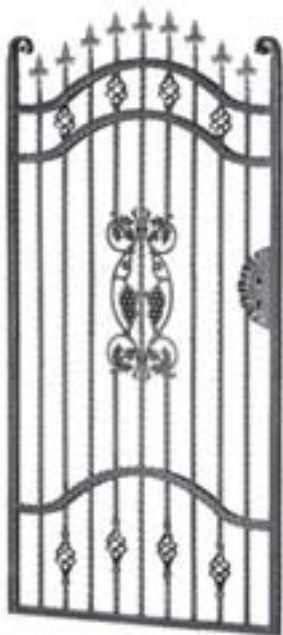

ogrodzenie



POSTAL



stalowe elementy kute naturalnie...