

POLSWAT

2011

stalowe elementy kute

wrought iron elements



NOWOŚĆ

KOWALSTWO I METALOPLASTYKA

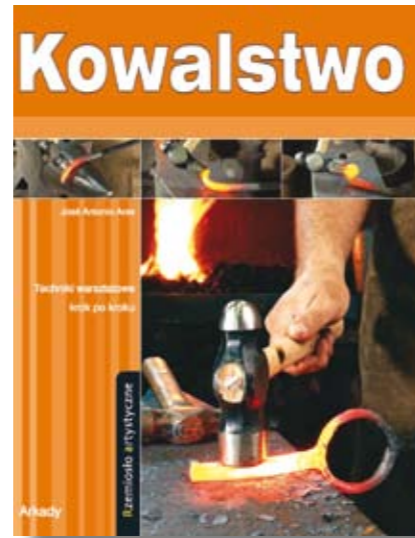

NOWOŚĆ

KOWALSTWO



METALOPLASTYKA

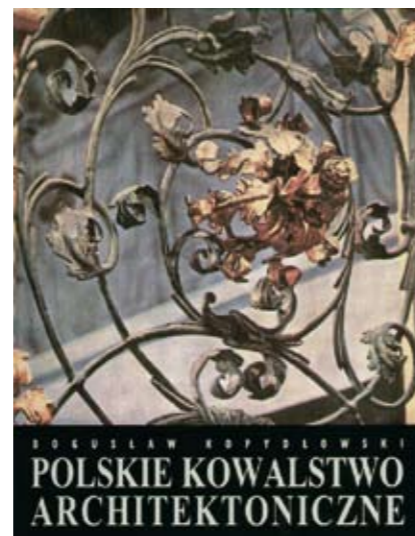

POLSKIE KOWALSTWO
ARCHITEKTONICZNE

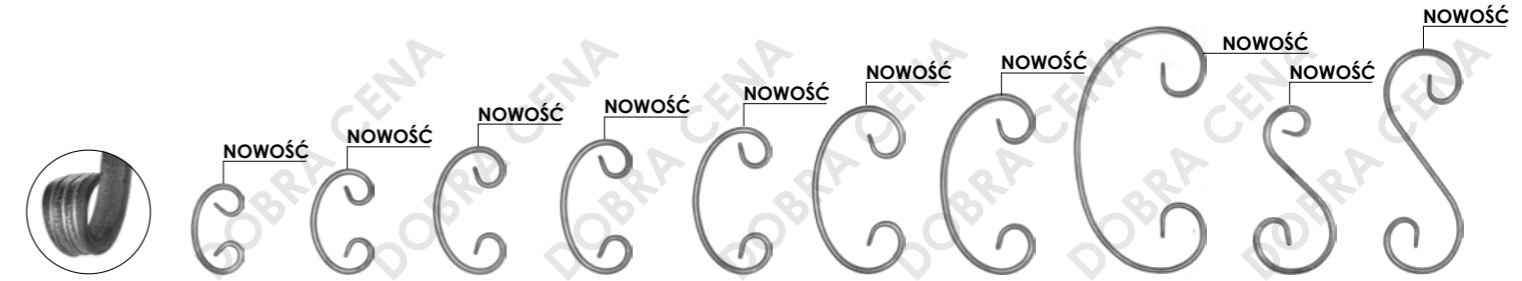

NR ART	01.061	01.062	01.064	01.065	01.066	01.067	01.068	01.069	01.070	01.070.05
H x L (mm)	80	95	115	120	130	150	160	220	150	200
∅ (mm)	∅ 11 x 5	∅ 11 x 5	∅ 11 x 5	∅ 11 x 5	∅ 11 x 5	∅ 11 x 5	∅ 11 x 5	∅ 11 x 5	∅ 11 x 5	∅ 11 x 5
W (kg)	0,085	0,100	0,116	0,116	0,128	0,152	0,152	0,220	0,135	0,180

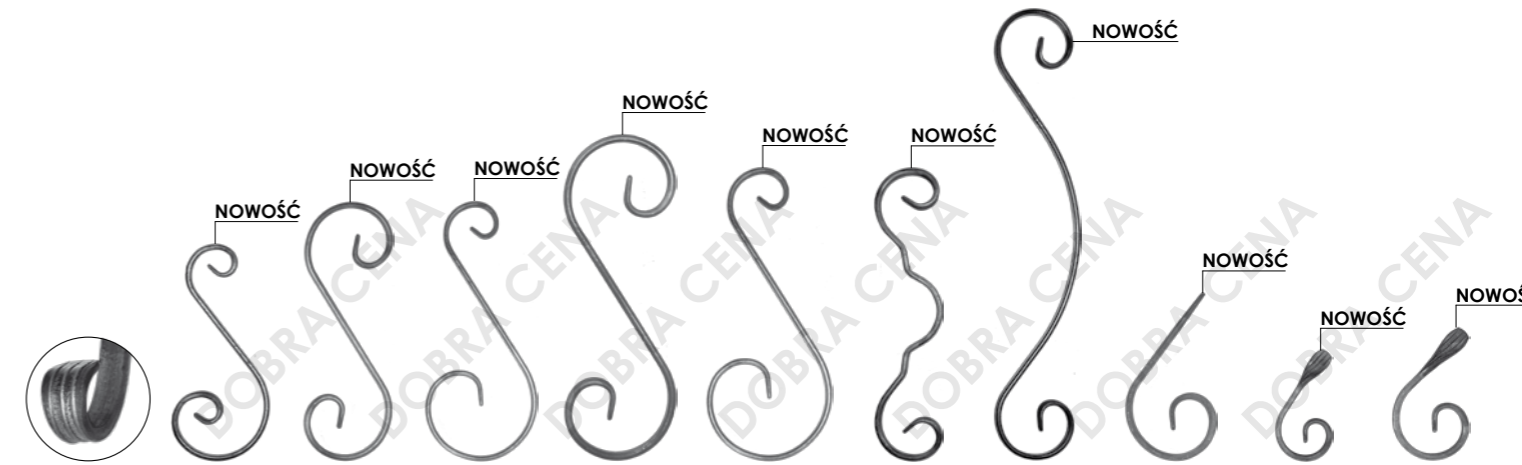

NR ART	01.071	01.071.05	01.072	01.072.05	01.073	01.075	01.076	01.077	01.078	01.079
H x L (mm)	195	230	230	290	260	250	460	150	100	120
∅ (mm)	∅ 11 x 5	∅ 11 x 5	∅ 11 x 5	∅ 11 x 5	∅ 11 x 5	∅ 11 x 5	∅ 11 x 5	∅ 11 x 5	∅ 11 x 5	∅ 11 x 5
W (kg)	0,175	0,220	0,260	0,345	0,225	0,180	0,335	0,128	0,085	0,110

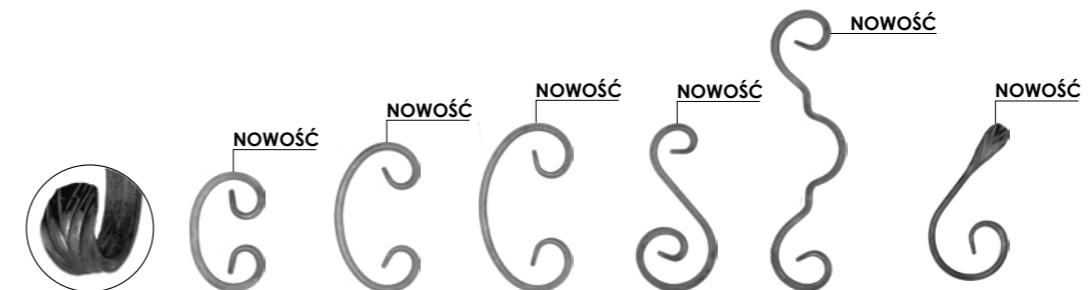

NR ART	01.086.02	01.086.05	01.086.07	01.086.10	01.086.15	01.086.19
H x L (mm)	100 x 60	125 x 75	150 x 80	150 x 70	250 x 75	120 x 80
∅ (mm)	∅ 12 x 6	∅ 12 x 6	∅ 12 x 6	∅ 12 x 6	∅ 12 x 6	∅ 12 x 6
W (kg)	0,160	0,180	0,190	0,215	0,255	0,155

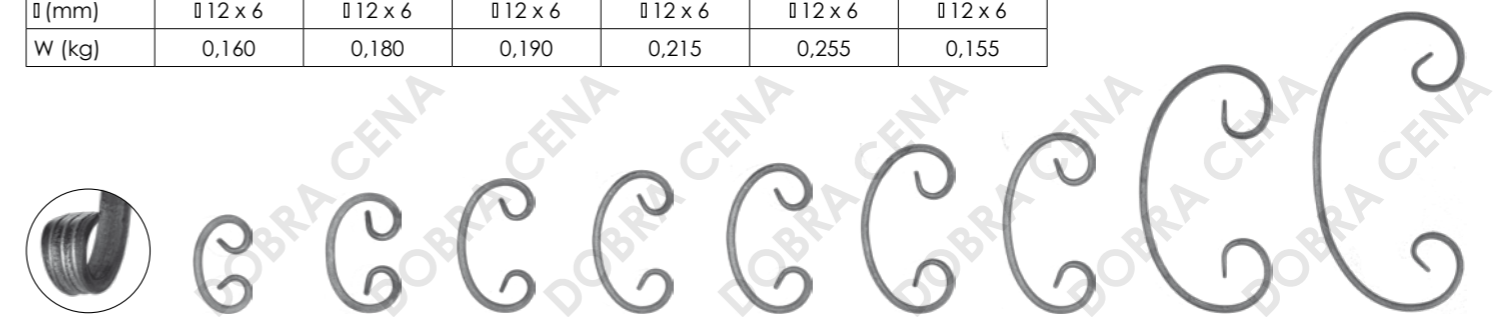

NR ART	01.092.02	01.092	01.094	01.095	01.096	01.097	01.097.02	01.098.02	01.099.02
H x L (mm)	80 x 50	95 x 60	115 x 75	120 x 70	130 x 70	150 x 75	160 x 80	220 x 110	270 x 120
∅ (mm)	∅ 12 x 6	∅ 12 x 6	∅ 12 x 6	∅ 12 x 6	∅ 12 x 6	∅ 12 x 6	∅ 12 x 6	∅ 12 x 6	∅ 12 x 6
W (kg)	0,120	0,155	0,180	0,180	0,180	0,215	0,215	0,310	0,400

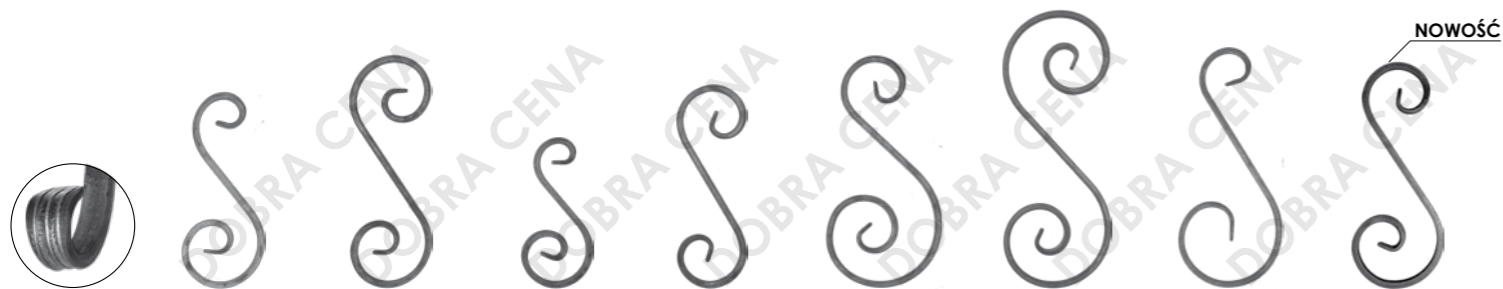

NR ART	01.091.11	01.091.19	01.100	01.100.05	01.101	01.101.05	01.102	01.103
H x L (mm)	195 x 80	230 x 80	150 x 70	200 x 70	230 x 110	290 x 110	260 x 110	225 x 90
□ (mm)	□ 12 x 6	□ 12 x 6	□ 12 x 6	□ 12 x 6	□ 12 x 6	□ 12 x 6	□ 12 x 6	□ 12 x 6
W (kg)	0,255	0,328	0,215	0,255	0,370	0,490	0,320	0,320



NR ART	01.083.27	01.105	01.108	01.109	01.114.28	01.121	01.121.01	01.121.02
H x L (mm)	150 x 95	250 x 75	100 x 65	120 x 80	450 x 80	320 x 80	220 x 80	220 x 80
□ (mm)	□ 12 x 6	□ 12 x 6	□ 12 x 6	□ 12 x 6	□ 12 x 6	□ 12 x 6	□ 12 x 6	□ 12 x 6
W (kg)	0,180	0,255	0,135	0,155	0,470	0,280	0,245	0,245

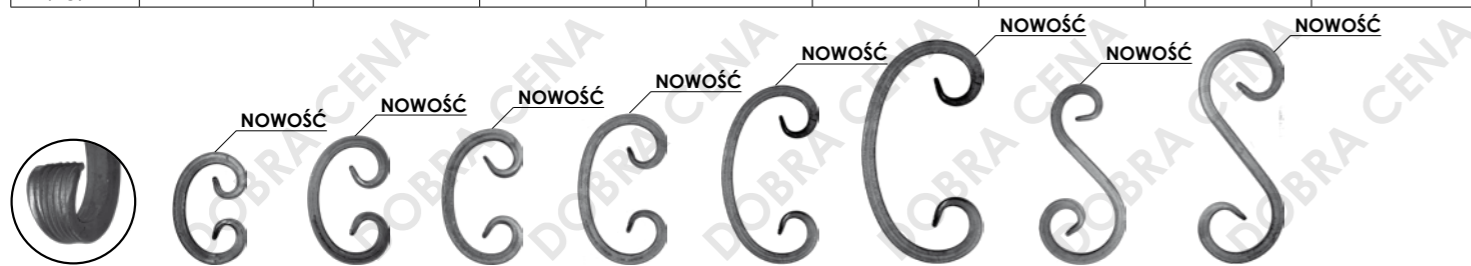

NR ART	01.293	01.295	01.296	01.297	01.298	01.299	01.310	01.310.05
H x L (mm)	100	120	130	150	180	220	180	220
□ (mm)	□ 10 x 10	□ 10 x 10	□ 10 x 10	□ 10 x 10	□ 10 x 10	□ 10 x 10	□ 10 x 10	□ 10 x 10
W (kg)	0,215	0,235	0,260	0,300	0,330	0,480	0,330	0,420

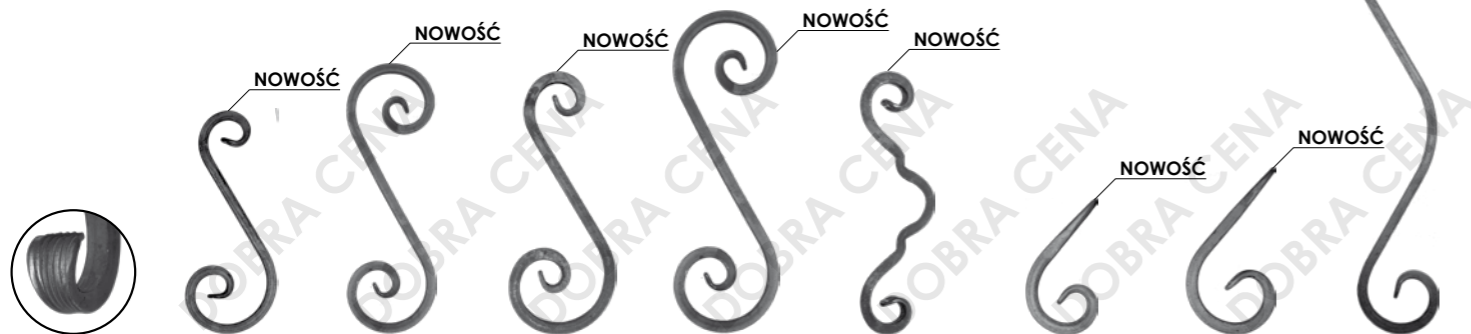

NR ART	01.311	01.311.05	01.312	01.312.05	01.315	01.319	01.320	01.328
H x L (mm)	250	300	290	360	290	120	150	450
□ (mm)	□ 10 x 10	□ 10 x 10	□ 10 x 10	□ 10 x 10	□ 10 x 10	□ 10 x 10	□ 10 x 10	□ 10 x 10
W (kg)	0,420	0,560	0,515	0,680	0,370	0,180	0,235	0,610



NR ART	01.395	01.396	01.397	01.398	01.398.02	01.400	01.400.05
H x L (mm)	120 x 75	130 x 75	150 x 90	180 x 100	220 x 125	180 x 90	200 x 90
□ (mm)	□ 12 x 12	□ 12 x 12	□ 12 x 12	□ 12 x 12	□ 12 x 12	□ 12 x 12	□ 12 x 12
W (kg)	0,365	0,385	0,420	0,465	0,680	0,465	0,520

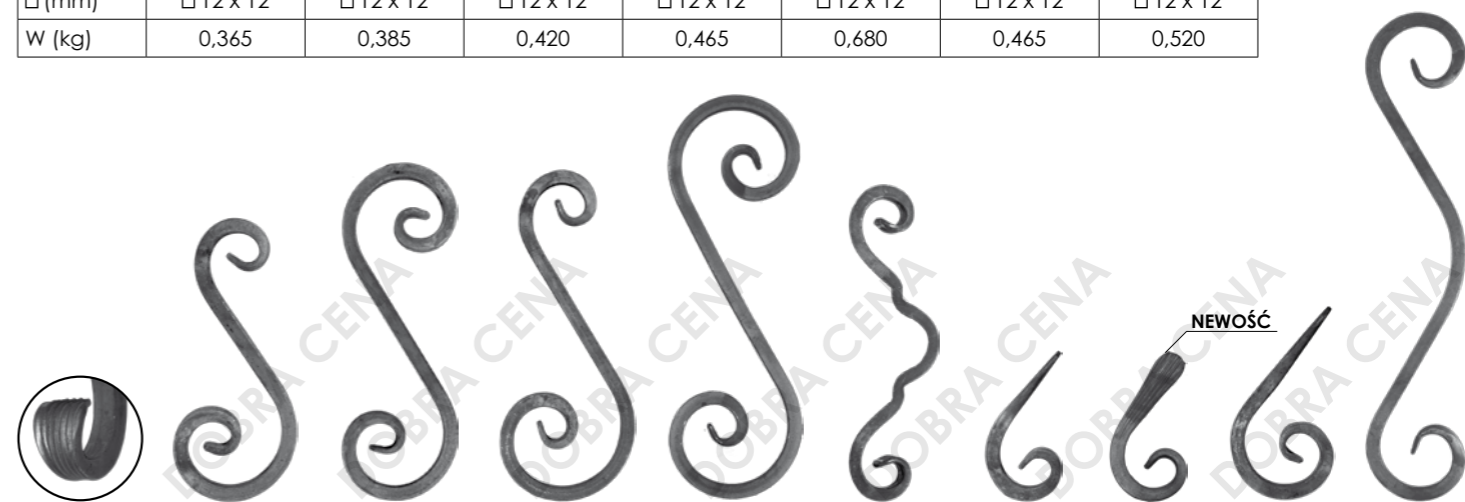

NR ART	01.401	01.401.05	01.402	01.402.05	01.405	01.409	01.409.01	01.410	01.414.28
H x L (mm)	250 x 100	300 x 100	290 x 120	360 x 120	275 x 85	130 x 65	130 x 65	170 x 90	450 x 85
□ (mm)	□ 12 x 12	□ 12 x 12	□ 12 x 12	□ 12 x 12	□ 12 x 12	□ 12 x 12	□ 12 x 12	□ 12 x 12	□ 12 x 12
W (kg)	0,590	0,790	0,725	0,970	0,520	0,245	0,245	0,340	0,860



NR ART	φ (mm)	□ (mm)	W (kg)
02.016	φ 100	□ 12 x 12	0,280
02.017	φ 120	□ 12 x 12	0,360
02.018.08	φ 100	□ 14 x 14	0,410
02.018.11	φ 120	□ 14 x 14	0,470



NR ART	φ (mm)	□ (mm)	W (kg)
02.031	φ 100	□ 12 x 6	0,160
02.032	φ 120	□ 12 x 6	0,200
02.033	φ 130	□ 12 x 6	0,250
02.035.03	φ 105	□ 12 x 6	0,160
02.035.04	φ 110	□ 12 x 6	0,170



NR ART	φ (mm)	□ (mm)	W (kg)
02.065.01	φ 100	□ 12 x 6	0,190
02.065.02	φ 120	□ 12 x 6	0,230



NR ART	06.033	06.033.04	06.034	06.034.05
H x L (mm)	300 x 80	300 x 80	300 x 80	300 x 80
□ (mm)	□ 12 x 12	□ 12 x 12	□ 14 x 14	□ 14 x 14
W (kg)	0,420	0,440	0,560	0,580



NR ART	02.063.03	02.080	02.081	02.082	02.083	02.084	02.086	02.086.01	02.087
H x L (mm)	70 x 70	130 x 60	135 x 65	145 x 65	170 x 80	180 x 95	120 x 60	140 x 75	190 x 105
□ (mm)	□ 6 x 6	□ 12 x 12	□ 14 x 14	□ 16 x 16	□ 20 x 20	□ 24 x 24	□ 12 x 12	□ 15 x 15	□ 24 x 24
W (kg)	0,195	0,200	0,250	0,360	0,800	1,050	0,175	0,270	0,900



NR ART	H (mm)	L (mm)	□ (mm)	W (kg)
02.252.11	225	760	□ 14 x 6	2,300
02.252.12	225	760	□ 20 x 6	3,300



NR ART	H (mm)	L (mm)	□ (mm)	W (kg)
02.252.21	330	1100	□ 14 x 6	4,050
02.252.22	330	1100	□ 20 x 6	5,600



NR ART	02.301.01	02.301.02	02.301.03	02.301.04	02.301.05	02.301.06	02.301.07	02.301.08	02.301.09
H x L (mm)	150 x 75	210 x 125	240 x 170	170 x 120	170 x 120	260 x 180	260 x 180	270 x 200	270 x 200
□ (mm)	□ 12 x 6	□ 12 x 6	□ 12 x 12	□ 12 x 12	□ 12 x 12	□ 12 x 12	□ 12 x 12	□ 12 x 12	□ 12 x 12
W (kg)	0,160	0,260	0,720	0,400	0,400	0,980	0,980	1,080	1,080



NR ART	02.301.10	02.301.11	02.301.12	02.301.13	02.301.14	02.301.15
H x L (mm)	360 x 280	360 x 280	600 x 420	600 x 420	410 x 340	410 x 340
□ (mm)	□ 12 x 12	□ 12 x 12	□ 12 x 12	□ 12 x 12	□ 12 x 12	□ 12 x 12
W (kg)	1,480	1,480	2,600	2,600	2,020	2,020



NR ART	02.301.16	02.301.17	02.301.18	02.301.19	02.301.20
H x L (mm)	490 x 410	490 x 410	540 x 290	540 x 290	440 x 990
□ (mm)	□ 12 x 12	□ 12 x 12	□ 12 x 12	□ 12 x 12	□ 12 x 12
W (kg)	2,960	2,960	1,900	1,900	3,900



NR ART	02.301.21	02.302.01	02.302.02	02.302.03	02.302.04
H x L (mm)	440 x 990	340 x 150	340 x 150	500 x 320	500 x 320
□ (mm)	□ 12 x 12	□ 12 x 12	□ 12 x 12	□ 12 x 12	□ 12 x 12
W (kg)	3,900	0,920	0,920	1,980	1,980



NR ART	02.302.05	02.302.06	02.302.07	02.302.08
H x L (mm)	610 x 300	610 x 300	470 x 820	470 x 820
□ (mm)	□ 12 x 12	□ 12 x 12	□ 12 x 12	□ 12 x 12
W (kg)	2,640	2,640	3,350	3,350

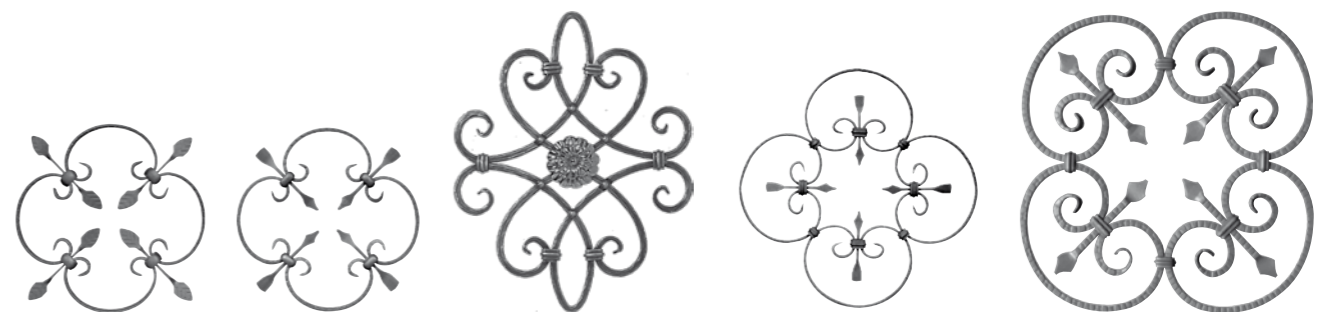

NR ART	03.005	03.007	03.018.12	03.020	03.025
H x L (mm)	250 x 250	250 x 250	530 x 420	380 x 380	590 x 590
□ (mm)	□ 20 x 4	□ 10 x 5	□ 12 x 12	□ 10 x 5	□ 12 x 12
W (kg)	1,000	0,700	4,150	1,320	5,750

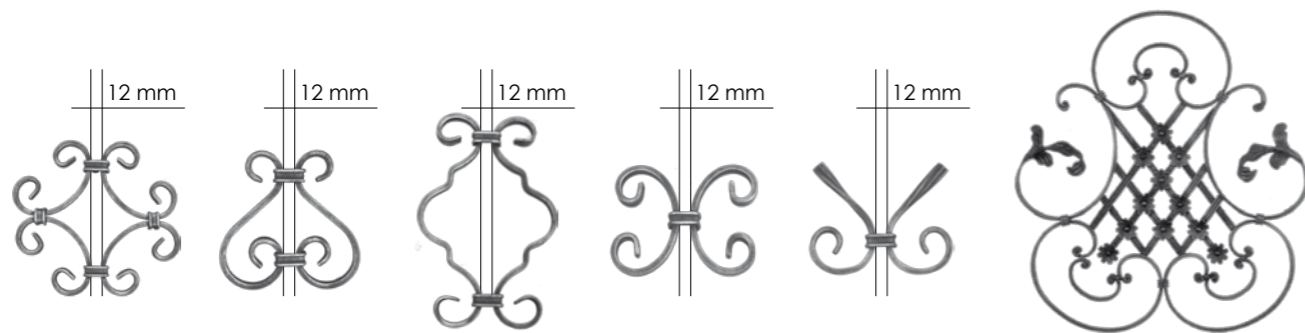

NR ART	03.027	03.043.01	03.051	03.052	03.109	03.248
H x L (mm)	210 x 220	150 x 150	250 x 160	120 x 150	120 x 170	710 x 650
□ (mm)	□ 12 x 6	□ 12 x 6	□ 12 x 6	□ 12 x 6	□ 12 x 6	□ 16 x 8
W (kg)	0,800	0,450	0,480	0,380	0,300	6,900



NR ART	03.301.09	03.302.12	03.302.62	03.303.05	03.303.06
H x L (mm)	500 x 280	490 x 330	540 x 385	430 x 250	∅ 380
□ (mm)	□ 12 x 12	□ 12 x 12	□ 12 x 12	□ 12 x 12	□ 12 x 12
W (kg)	2,140	3,580	4,520	2,000	3,900



NR ART	03.309.12	03.309.13	03.310.07	03.311.05	03.311.06
H x L (mm)	∅ 385	545 x 385	450 x 250	290 x 300	480 x 400
□ (mm)	□ 12 x 12	□ 12 x 12	□ 12 x 12	□ 12 x 12	□ 12 x 12
W (kg)	3,600	5,220	2,380		

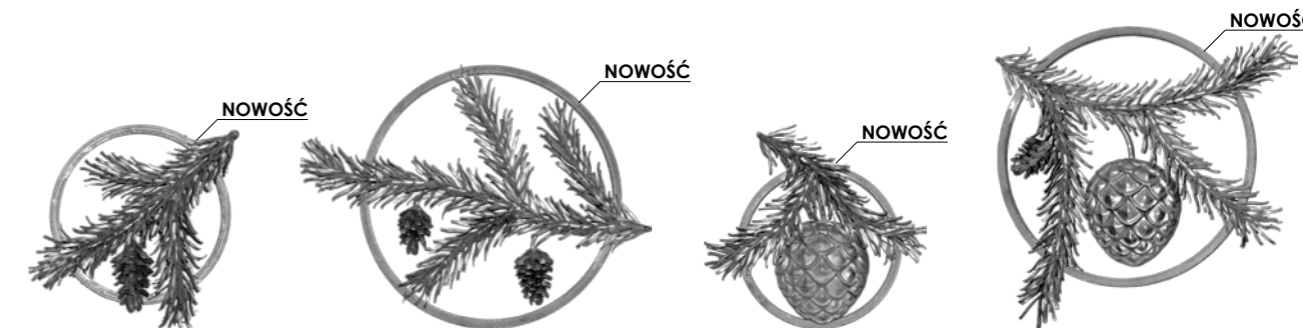

NR ART	03.312.06	03.312.07	03.312.08	03.312.09
H x L (mm)	300 x 330	390 x 510	290 x 340	450 x 475
□ (mm)	□ 12 x 12	□ 12 x 12	□ 12 x 12	□ 12 x 12



NR ART	03.304.05	03.304.06	03.305.03	03.305.04	03.306.05
H x L (mm)	355 x 250	440 x 385	420 x 385	460 x 385	∅ 380
□ (mm)	□ 12 x 12	□ 12 x 12	□ 12 x 12	□ 12 x 12	□ 12 x 12
W (kg)	1,740	3,500	3,850	3,600	4,150

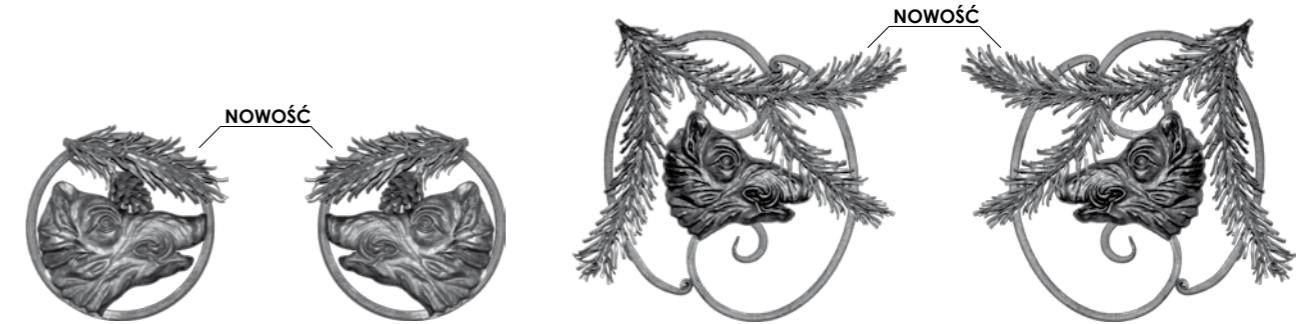

NR ART	03.312.14	03.312.15	03.312.16	03.312.17
H x L (mm)	260 x 270	260 x 270	470 x 520	470 x 520
□ (mm)	□ 12 x 12	□ 12 x 12	□ 12 x 12	□ 12 x 12



NR ART	03.306.06	03.307.11	03.307.61	03.308.15	03.309.11
H x L (mm)	445 x 385	490 x 330	485 x 385	400 x 450	525 x 250
□ (mm)	□ 12 x 12	□ 12 x 12	□ 12 x 12	□ 12 x 12	□ 12 x 12
W (kg)	4,300	2,380	4,640	3,000	2,480



NR ART	03.313.04	03.313.05	03.314.09	03.315.06
H x L (mm)	310 x 390	440 x 480	400 x 340	350 x 290
□ (mm)	□ 12 x 12	□ 12 x 12	□ 12 x 12	□ 12 x 12
W (kg)			2,380	2,380



NR ART	03.316.02	03.316.03	03.316.04	03.316.05
H x L (mm)	560 x 405	610 x 370	510 x 675	640 x 405
□ (mm)	□ 12 x 12	□ 12 x 12	□ 12 x 12	□ 12 x 12
W (kg)	3,960	5,780	6,060	4,720

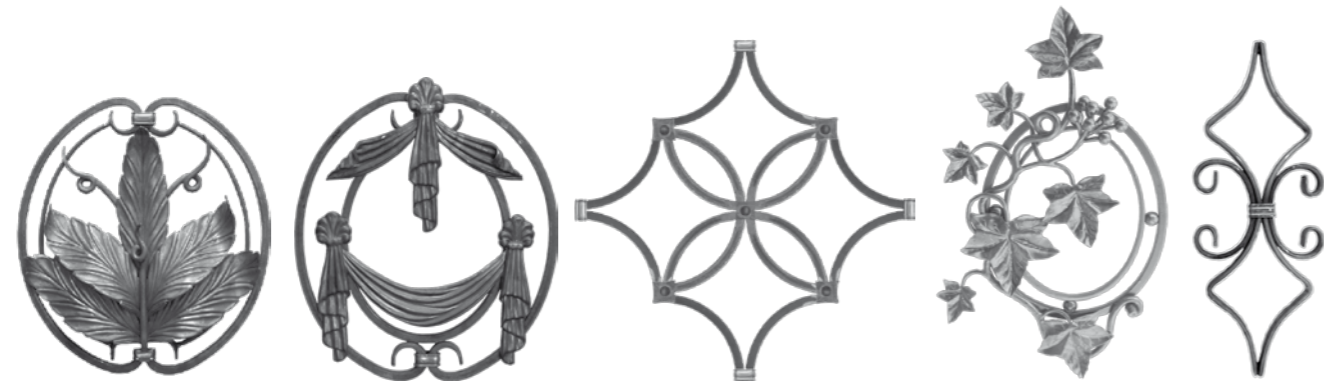

NR ART	03.316.06	03.316.07	03.316.08	03.317.06	03.401
H x L (mm)	420 x 385	440 x 385	516 x 516	500 x 300	420 x 145
□ (mm)	□ 12 x 12	□ 12 x 12	□ 12 x 12	□ 12 x 12	□ 12 x 6
W (kg)	4,080	3,490	3,820	2,840	0,920

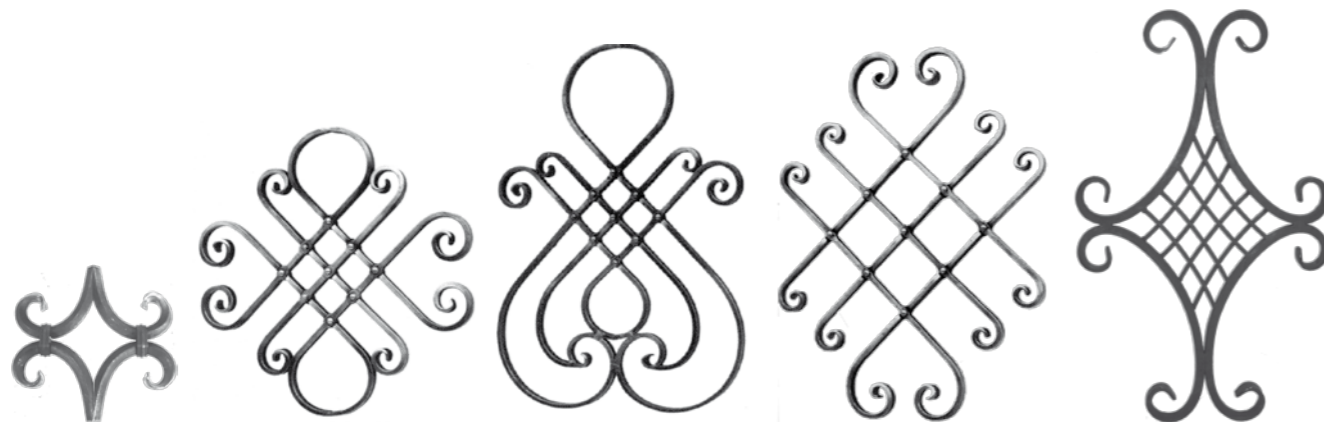

NR ART	03.512	03.571	03.574	03.581	03.603
H x L (mm)	210 x 210	400 x 410	575 x 400	440 - 580 x 380 - 620	680 x 420
□ (mm)	◇ 14 x 14	□ 16 x 8	□ 16 x 8	□ 16 x 8	□ 12 x 12
W (kg)	1,350	3,000	4,400	3,850	3,250



NR ART	04.016	04.057.01	04.057.02	04.057.03	04.057.04	04.060	04.070	04.075	04.083	04.090.09
□ (mm)	□ 40 x 4	□ 12 x 12	□ 12 x 12	□ 12 x 12	□ 12 x 12	□ 12 x 12	□ 12 x 12	□ 12 x 12	□ 12 x 12	□ 12 x 12
H x L (mm)	800 x 135	750 x 200	750 x 200	750 x 200	750 x 200	950 x 200	950 x 200	950 x 125	950 x 125	950 x 125
W (kg)	1,500	2,000	2,000	2,000	2,380			1,150	1,150	1,000
NR ART								04.079	04.087	04.090.13
□ (mm)								□ 14 x 14	□ 14 x 14	□ 14 x 14
H x L (mm)								950 x 125	950 x 125	950 x 125
W (kg)								1,600	1,600	1,450

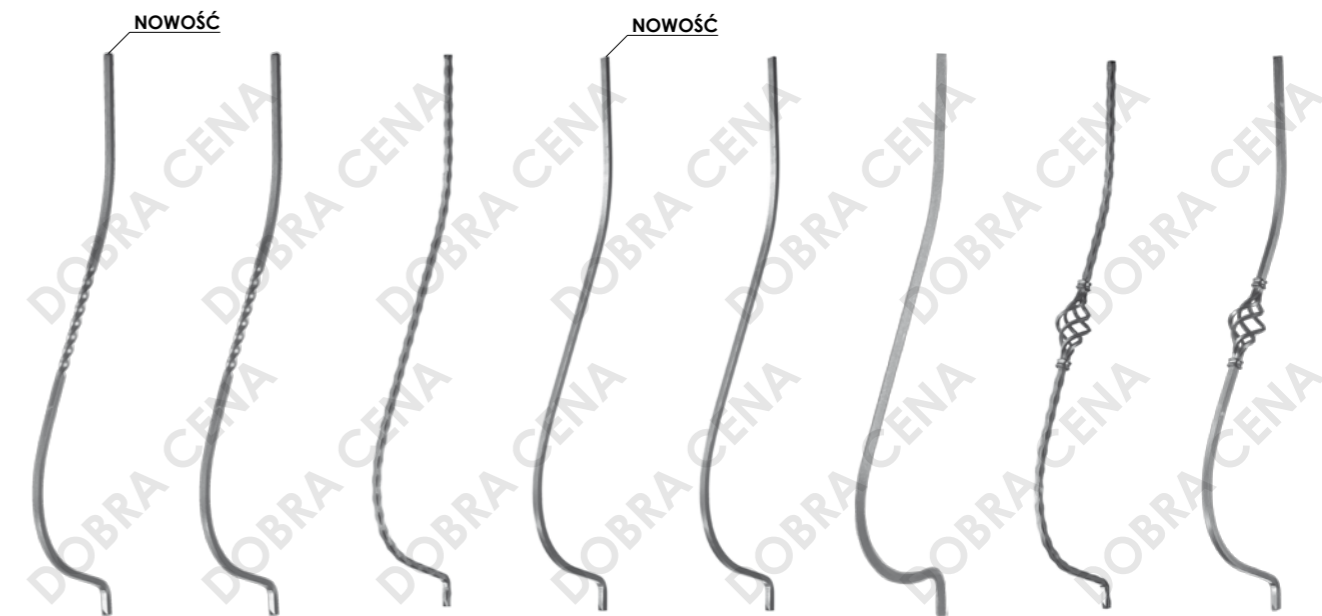

NR ART	04.098	04.098.25	04.103	04.106.04	04.106.05	04.106.25	04.107	04.110.05
□ (mm)	□ 10 x 10	□ 12 x 12	□ 12 x 12	□ 10 x 10	□ 12 x 12	◇ 12 x 12	□ 12 x 12	□ 12 x 12
H x L (mm)	950 x 200	950 x 200	950 x 200	950 x 200	950 x 200	950 x 200	950 x 200	950 x 200
W (kg)	0,760	1,200	1,120	0,760	1,200	1,200	1,440	1,240
NR ART		04.098.29	04.106.01		04.106.09	04.106.29	04.110.01	04.110.09
□ (mm)		□ 14 x 14	□ 14 x 14		□ 14 x 14	◇ 14 x 14	□ 14 x 14	□ 14 x 14
H x L (mm)		950 x 200	950 x 200		950 x 200	950 x 200	950 x 200	950 x 200
W (kg)		1,700	1,700		1,750	1,750	1,750	1,700

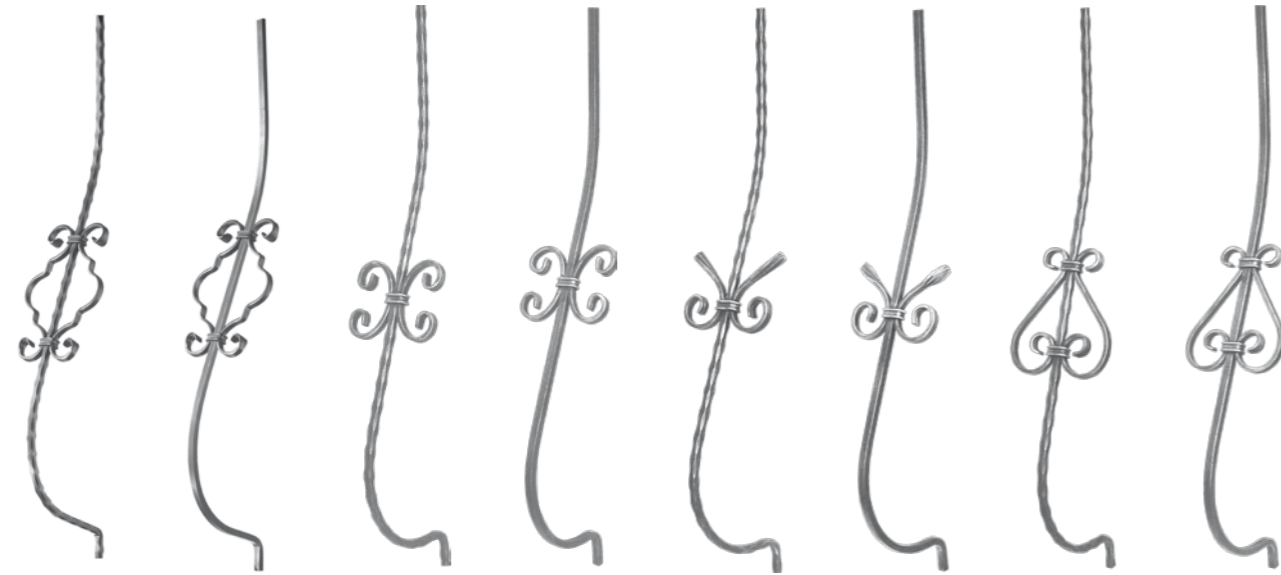

NR ART	04.111	04.114.05	04.138	04.138.05	04.139	04.139.05	04.148	04.148.05
□ (mm)	□ 12 x 12	□ 12 x 12	□ 12 x 12	□ 12 x 12	□ 12 x 12	□ 12 x 12	□ 12 x 12	□ 12 x 12
H x L (mm)	950 x 200	950 x 200	950 x 200	950 x 200	950 x 200	950 x 200	950 x 200	950 x 200
W (kg)	1,700	1,705	1,500	1,600	1,450	1,500	1,650	1,750
NR ART	04.114.01	04.114.09	04.138.01	04.138.09	04.139.01	04.139.09	04.148.01	04.148.09
□ (mm)	□ 14 x 14	□ 14 x 14	□ 14 x 14	□ 14 x 14	□ 14 x 14	□ 14 x 14	□ 14 x 14	□ 14 x 14
H x L (mm)	950 x 200	950 x 200	950 x 200	950 x 200	950 x 200	950 x 200	950 x 200	950 x 200
W (kg)	2,350	2,350	2,100	2,200	2,000	2,050	1,750	2,250

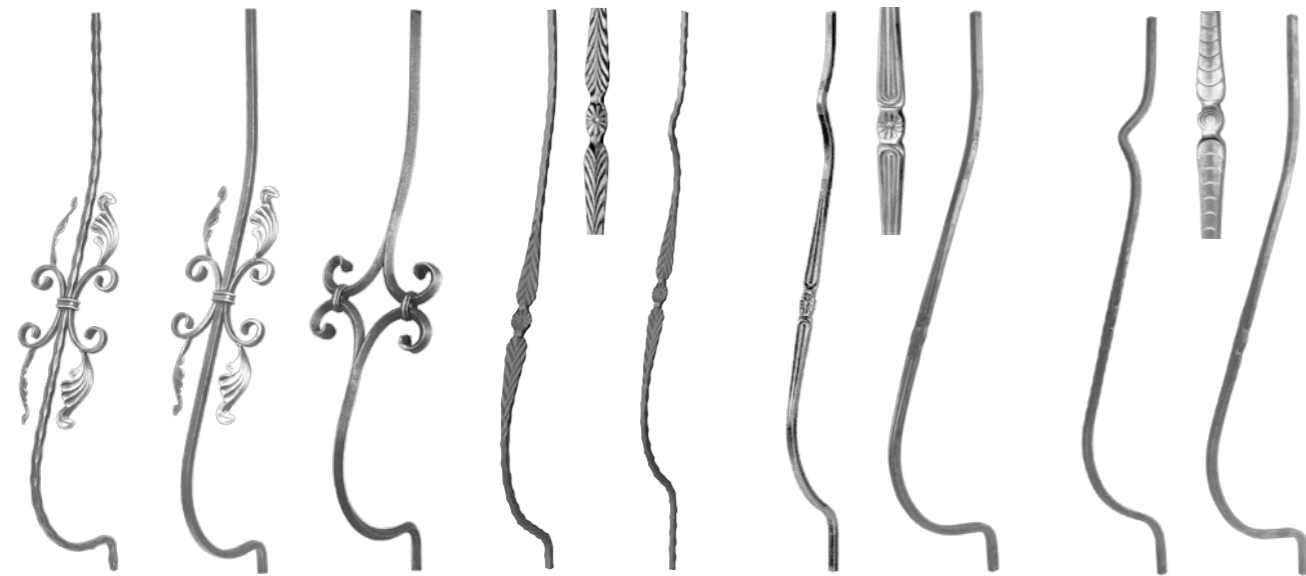

NR ART	04.153	04.153.05	04.156	06.053	06.055	09.516.07	09.516.08	09.516.09	09.516.10
□ (mm)	□ 12 x 12	□ 12 x 12	◇ 14 x 14	□ 12 x 12	□ 12 x 12	□ 12 x 12	□ 12 x 12	□ 12 x 12	□ 12 x 12
H x L (mm)	950 x 200	950 x 200	950 x 200	950 x 200	950 x 125	950 x 125	950 x 200	950 x 125	950 x 200
W (kg)	1,700	1,800	2,600	1,150	1,100	1,200	1,200	1,200	1,200
NR ART	04.153.01	04.153.09							
□ (mm)	□ 14 x 14	□ 14 x 14							
H x L (mm)	950 x 200	950 x 200							
W (kg)	2,200	2,300							

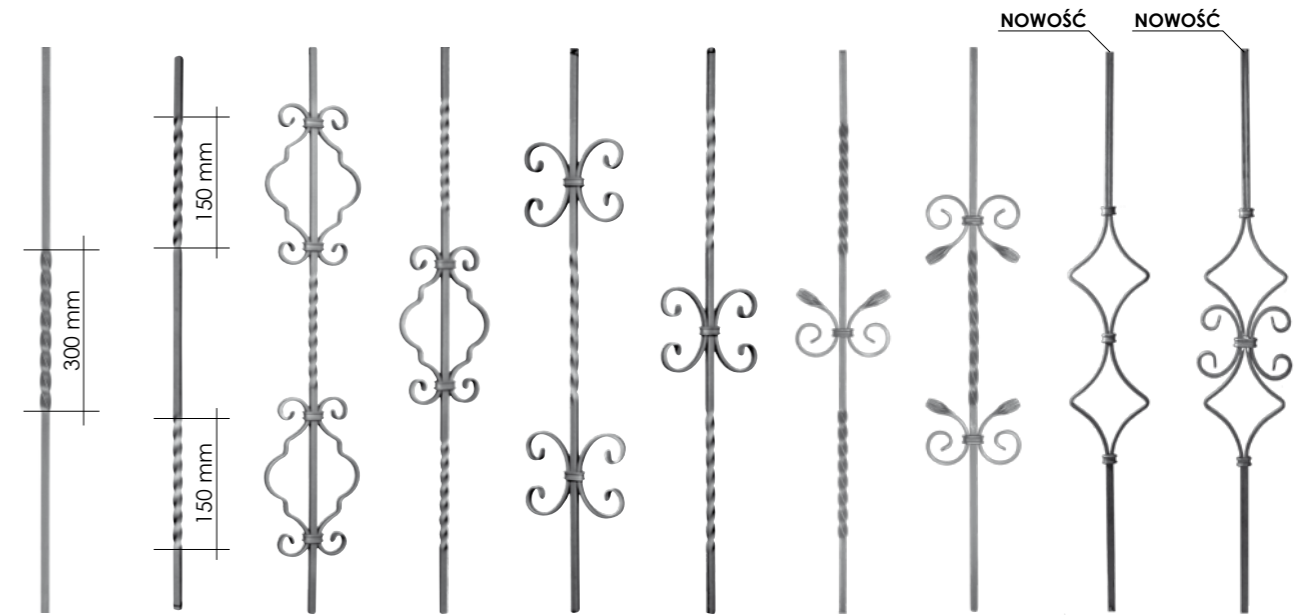

NR ART	05.045	05.046	05.065	05.066	05.067	05.068	05.071.01	05.071.03	05.072	05.073
□ (mm)	□ 12 x 12	□ 12 x 12	□ 12 x 12	□ 12 x 12	□ 12 x 12	□ 12 x 12	□ 12 x 12	□ 12 x 12	□ 12 x 12	□ 12 x 12
H x L (mm)	950	950	950 x 165	950 x 165	950 x 150	950 x 150	950 x 150	950 x 150	950 x 130	950 x 155
W (kg)	1,100	1,100	2,100	1,550	1,850	1,460	1,400	1,700	1,180	1,540
NR ART	05.045.01	05.046.01								
□ (mm)	□ 14 x 14	□ 14 x 14								
H x L (mm)	950	950								
W (kg)	1,420	1,420								

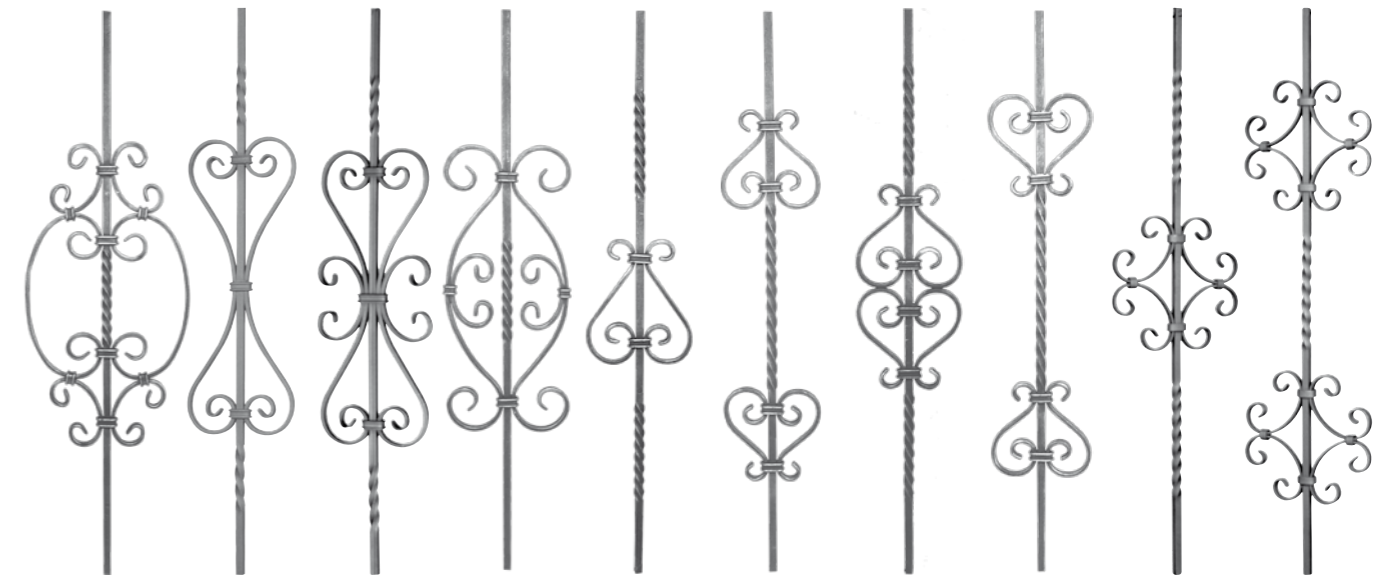

NR ART	05.074	05.075	05.076	05.076.01	05.077	05.077.01	05.077.02	05.077.03	05.083	05.084
□ (mm)	□ 12 x 12	□ 12 x 12	□ 12 x 12	□ 12 x 12	□ 12 x 12	□ 12 x 12	□ 12 x 12	□ 12 x 12	□ 12 x 12	□ 12 x 12
H x L (mm)	950 x 220	950 x 170	950 x 180	950 x 180	950 x 180	950 x 150	950 x 150	950 x 150	950 x 220	950 x 220
W (kg)	2,370	2,150	2,400	2,400	1,700	2,000	2,000	2,000	1,600	2,100

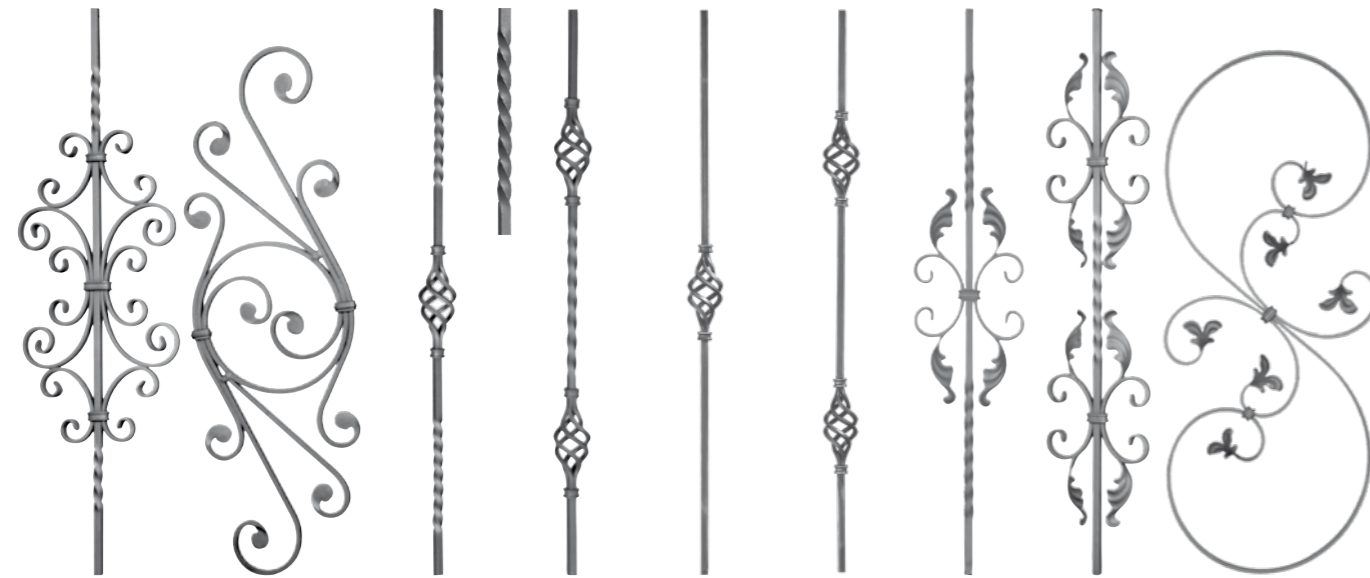

NR ART	05.085	05.108	05.123	05.124	05.124.02	05.124.04	05.130	05.131	05.142
□ (mm)	□ 12 x 12	□ 8 x 8	□ 12 x 12	□ 12 x 12	□ 12 x 12	□ 12 x 12	□ 12 x 12	□ 12 x 12	□ 12 x 6
H x L (mm)	950 x 250	800 x 280	950	950	950	950	950 x 170	950 x 170	860 x 350
W (kg)	2,950	2,400	1,100	1,220	1,100	1,200	1,400	1,700	2,300
NR ART			05.123.01	05.124.01	05.124.03	05.124.05			
□ (mm)			□ 14 x 14	□ 14 x 14	□ 14 x 14	□ 14 x 14			
H x L (mm)			950	950	950	950			
W (kg)			1,600	1,650	1,500	1,650			

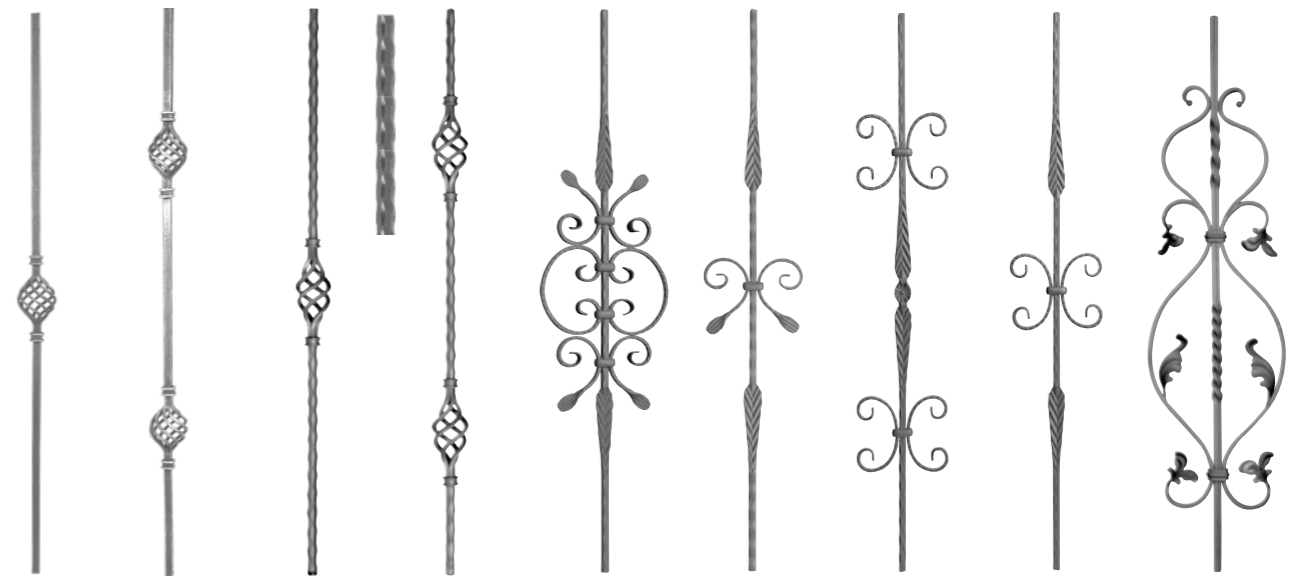

NR ART	05.434.01	05.435.01	06.008	06.009	06.040	06.050	06.051	06.052	07.019
□ (mm)	□ 12 x 12	□ 12 x 12	□ 12 x 12	□ 12 x 12	□ 12 x 12	□ 12 x 12	□ 12 x 12	□ 12 x 12	□ 12 x 12
H x L (mm)	950	950	950	950	950 x 170	950 x 170	950 x 170	950 x 170	900 x 230
W (kg)	1,150	1,150	1,100	1,200	1,860	1,480	1,480	1,480	2,550
NR ART			06.008.01	06.009.01					
□ (mm)			□ 14 x 14	□ 14 x 14					
H x L (mm)			950	950					
W (kg)			1,600	1,650					



NR ART	05.211.17	05.211.19	05.429.01	05.429.02	05.429.03	05.429.04	05.432	05.433	05.434	05.435
□ / φ (mm)	□ 12 x 12	□ 12 x 12	φ 30 x 1,5	φ 30 x 1,5	φ 30 x 1,5	φ 30 x 1,5	□ 12 x 12	□ 12 x 12	□ 12 x 12	□ 12 x 12
H x L (mm)	900 x 200	900 x 200	900	900	900	900	950	950	950	950
W (kg)	3,200	3,400	0,970	0,930	0,930	0,930	1,100	1,200	1,100	1,250



NR ART	07.301.10	07.301.11	07.302.16	07.302.17	07.303.01	07.305.01	07.307.01	07.308.01
φ/□ (mm)	□ 16 x 16	φ 14	φ 14	φ 14	φ 14	φ 14	φ 14	φ 14
H x L (mm)	760 x 200	950 x 90	900 x 270	950 x 200	950 x 275	950 x 165	950 x 180	950 x 180
W (kg)	4,650	2,340	3,420	2,540	2,200	1,930	2,220	2,280
NR ART		07.301.12		07.302.18	07.303.02	07.305.02		07.308.02
□ (mm)		□ 12 x 12		□ 12 x 12	□ 12 x 12	□ 12 x 12		□ 12 x 12
H x L (mm)		950 x 90		950 x 200	950 x 275	950 x 165		950 x 180
W (kg)		2,340		2,540	2,200	1,930		2,280



NR ART	07.309.01	07.310.01	07.310.06	07.311.01	07.313.01	07.317.01	07.314.10	07.802
φ/□ (mm)	φ14	φ14		φ14	φ14	φ14		□14 x 8
H x L (mm)	950 x 195	950 x 200	1070 x 520	950 x 180	950 x 180	950 x 250	815 x 485	1000 x 190
W (kg)	2,300	2,700	7,000			2,520	3,270	3,350
NR ART	07.309.02	07.310.02		07.311.02	07.313.02	07.317.02		
□ (mm)	□12 x 12	□12 x 12		□12 x 12	□12 x 12	□12 x 12		
H x L (mm)	950 x 195	950 x 200		950 x 180	950 x 180	950 x 250		
W (kg)	2,300	2,700				2,520		



NR ART	09.154.12	09.154.13	09.211	09.220	09.509	09.510	09.510.03	09.510.04	09.516.01	09.516.02
□ / φ (mm)	φ 10 x 2	φ 10 x 2	□12 x 12	□12 x 12	φ 14	φ 14	□14 x 14	□14 x 14	□12 x 12	□12 x 12
H (mm)	1000	1000	900	900	950	950	950	950	1000	1000
W (kg)	1,900	2,100	1,030	1,030	1,180	1,260	1,550	1,700	1,200	1,100



NR ART	09.516.03	09.516.04	09.535	09.626	09.628	09.632	09.633	11.002	11.003	11.012
□/□ (mm)	□12 x 12	□12 x 12	□12 x 12	□12 x 12	□12 x 12	□12 x 12	□12 x 12	□14 x 14	□14 x 14	□14/20
H (mm)	1000	1000	1000	950	950	950	950	950	950	950
W (kg)	1,200	1,100	1,200	1,030	1,030	1,080	1,080	1,350	1,640	1,960

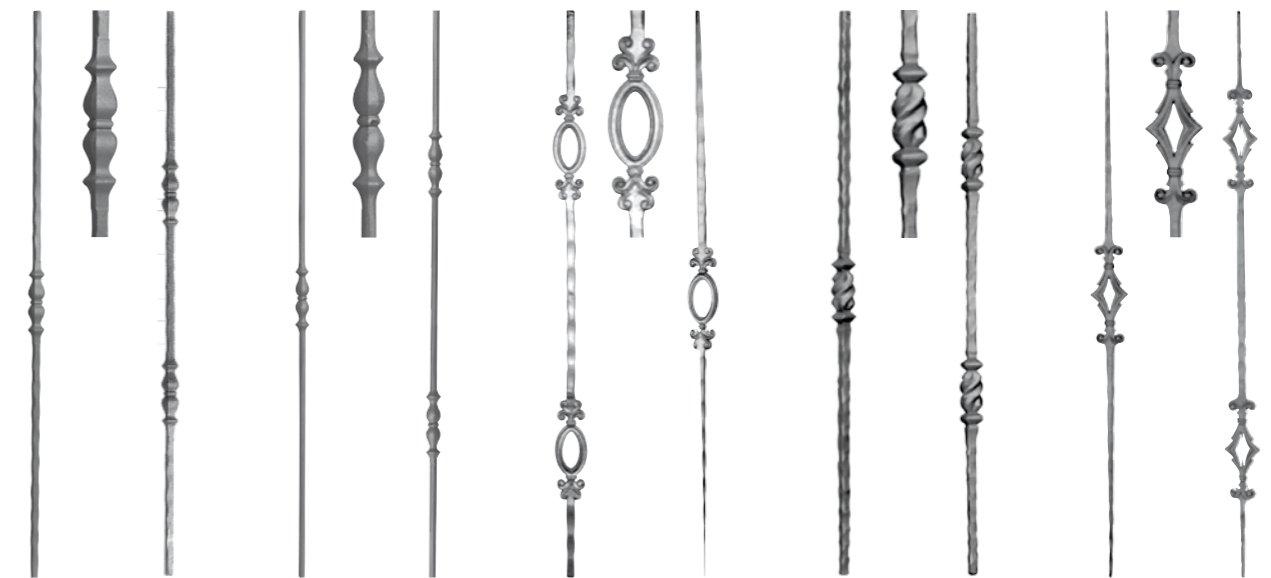

NR ART	11.011.01	11.011.02	11.017.01	11.017.02	11.032	11.033	11.036	11.037	11.038	11.039
φ/□ (mm)	□14 x 14	□14 x 14	φ12	φ12	□14 x 14	□14 x 14	□14 x 14	□14 x 14	□14 x 14	□14 x 14
H (mm)	1000	1000	1000	1000	1000	1000	950	950	1000	1000
W (kg)	1,250	1,640	1,050	1,250	1,600	1,480	1,580	1,900	1,450	1,600



NR ART	11.048	11.053.21	11.053.30	11.054	11.055	11.057	11.059	11.061	11.061.12
□ (mm)	□ 25 x 25	□ 25 x 25	□ ∅ 25	□ 25 x 25	□ 25 x 25	□ 25 x 25	□ 25 x 25	□ 25 x 25	□ 25 x 25
H (mm)	1200	1200	1200	1200	1200	1200	1200	1200	1200
W (kg)	5,900	5,800	5,200	7,460	4,750	6,740	5,600	5,600	6,000



NR ART	11.064.16	11.070	11.071	11.312.02	11.312.03	11.312.05	11.312.06
∅ / □ (mm)	∅ 50	□ 25 x 25	□ 25 x 25	□ 30 x 30	□ 30 x 30		
H (mm)	1300	1200	1200	1000	1000	960	960
W (kg)	8,000	5,900	5,900	9,500	9,100	18,300	22,000

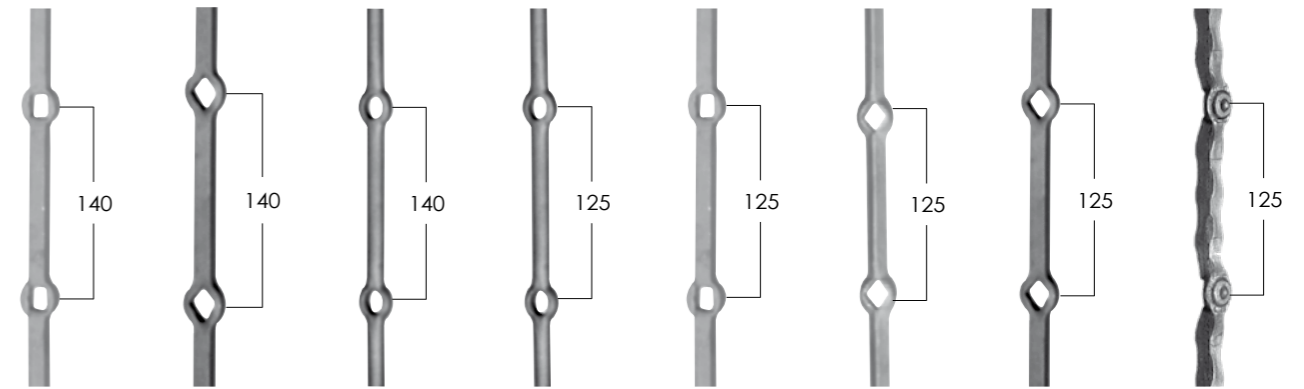

NR ART	08.001	08.013	08.023	08.115	08.119	08.123	08.127	08.105
□ (mm)	□ 14 x 14	□ 14 x 14	□ 14 x 14	□ 14 x 14	□ 14 x 14	◇ 14 x 14	□ 14 x 14	□ 14 x 14
H (mm)	2000	2000	2000	2000	2000	2000	2000	2000
Otw.	□ 14 / 14 otw.	◇ 14 / 14 otw.	∅ 14 / 14 otw.	∅ 14 / 15 otw.	□ 14 / 15 otw.	◇ 14 / 14 otw.	◇ 14 / 14 otw.	
W (kg)	3,080	3,080	2,420	2,420	3,080	3,080	3,080	2,780



NR ART	12.005	12.017	12.018.01	12.021	12.025	12.028
∩ (mm)	∩ 40 x 8	∩ 40 x 8	∩ 40 x 8	∩ 40 x 8	∩ 40 x 8	∩ 40 x 8
H x L (mm)	3000	350 x 100	300 x 180	600	300 x 300	200 x 200
W (kg)	7,500	1,200	1,500	2,000	1,500	1,050



NR ART	12.029	12.032	12.032.01	12.034	12.035	12.036
∩ (mm)	∩ 40 x 8	∩ 40 x 8	∩ 40 x 8	∩ 40 x 8	∩ 40 x 8	∩ 40 x 8
H x L (mm)	3000	350 x 100	300 x 180	600	300 x 300	200 x 200
W (kg)	7,500	1,200	1,500	2,000	1,500	1,050

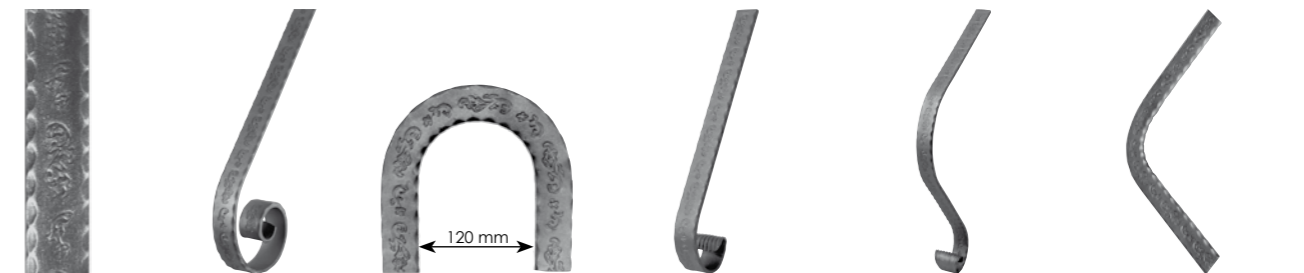

NR ART	12.038	12.040.01	12.041	12.042.01	12.043.01	12.044
∩ (mm)	∩ 40 x 8	∩ 40 x 8	∩ 40 x 8	∩ 40 x 8	∩ 40 x 8	∩ 40 x 8
H x L (mm)	3000	300 x 180	200 x 200	350 x 100	600	300 x 300
W (kg)	7,500	1,500	1,050	1,200	2,000	1,500



NR ART	12.045	12.046.01	12.047	12.047.01	12.048.01	12.049
□ (mm)	□ 40 x 8	□ 40 x 8	□ 40 x 8	□ 40 x 8	□ 40 x 8	□ 40 x 8
H x L (mm)	3000	300 x 180	350 x 100	300 x 300	600	200 x 200
W (kg)	7,500	1,500	1,200	1,500	2,000	1,050

NOWOŚĆ



NR ART	12.053	12.053.01	12.055	12.056	12.056.01	12.057.02	12.058.01
H x L (mm)	3000	400	300 x 300	300 x 100	300 x 170	600	200 x 200
□ (mm)	40 x 10	40 x 10	40 x 10	40 x 10	40 x 10	40 x 10	40 x 10
NR ART	12.054	12.054.01	12.055.01	12.057	12.057.01	12.058	12.058.02
□ (mm)	50 x 10	50 x 10	50 x 10	50 x 10	50 x 10	50 x 10	50 x 10



NR ART	12.063	12.068	12.072	12.078
H x L (mm)	3000	300 x 170	300 x 100	600
□ (mm)	40 x 8	40 x 8	40 x 8	40 x 8
W (kg)	5,600		0,960	1,700
NR ART	12.066	12.070	12.075	12.080
□ (mm)	50 x 10	50 x 10	50 x 10	50 x 10
W (kg)	9,200		1,560	2,750



NR ART	12.084	12.084.05	12.085.05	12.086	12.086.12	12.087	12.087.04
H x L (mm)	3000	300 x 300	200 x 200	400	300 x 100	300 x 170	600
□ (mm)	50 x 14	50 x 14	50 x 14	50 x 14	50 x 14	50 x 14	50 x 14
W (kg)	13,000	2,200	2,200	2,900	2,200	2,820	3,900
NR ART	12.084.01	12.084.06	12.085.06	12.086.01	12.086.13	12.087.01	12.087.05
□ (mm)	40 x 12	40 x 12	40 x 12	40 x 12	40 x 12	40 x 12	40 x 12
W (kg)	9,000	1,450	1,450	1,950	1,480	1,880	2,610

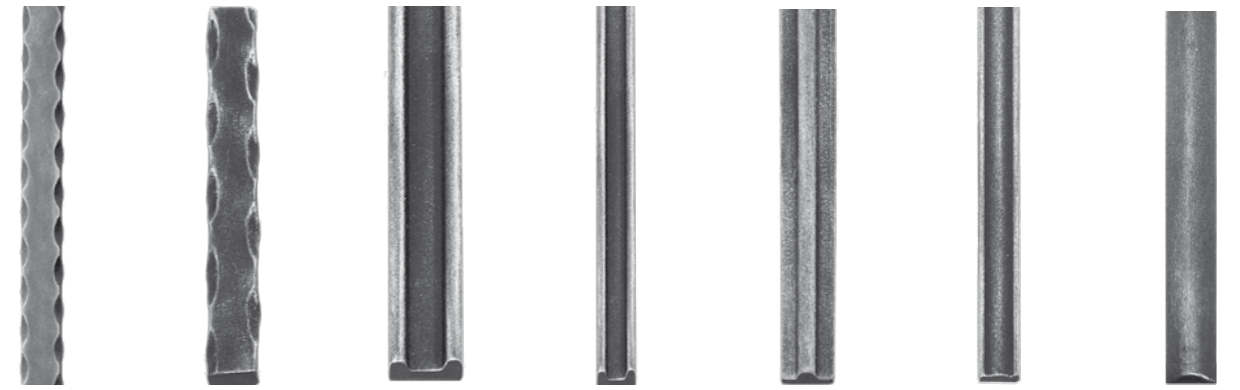

NR ART	12.001	12.096	12.108.01	12.108	12.110	12.114	12.118
□ (mm)	25 x 6	20 x 10	25 x 8	14 x 4	18 x 5	14 x 3	14 x 4
H (mm)	3000	3000	3000	4000	4000	3000	4000
W (kg)	3,500	4,500	3,500	1,650	2,000	0,860	1,300
NR ART	12.003	12.096.01	12.108.02	12.109	12.111	12.115	12.119
□ (mm)	30 x 6	12 x 6	30 x 8	18 x 5	14 x 4	16 x 4	16 x 5
H (mm)	3000	3000	3000	4000	4000	3000	4000
W (kg)	4,200	1,600	3,700	2,800	1,450	1,260	2,000
NR ART	12.006.10	12.108.05			12.116	12.120	
□ (mm)	40 x 6	40 x 8			20 x 4	21 x 6	
H (mm)	3000	3000			3000	4000	
W (kg)	5,650	4,450			1,570	3,000	

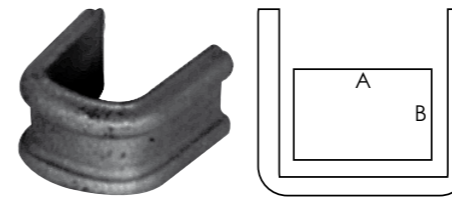

NR ART	□ (mm)	A x B (mm)	W (kg)
12.122.12	14 x 4	□ 12 x 12	0,056
12.122.14	14 x 4	□ 14 x 14	0,060
12.122.18	14 x 4	□ 18 x 12	0,068
12.122.24	14 x 4	□ 24 x 12	0,084



NR ART	H (mm)	□ (mm)	W (kg)
12.175	3000	□ 12 x 12	3,000
12.176	3000	□ 14 x 14	4,200
12.177	3000	□ 16 x 16	5,800



NR ART	H (mm)	φ (mm)	W (kg)
12.196.15	3000	φ 8	1,130
12.196.16	3000	φ 10	1,800
12.196.17	3000	φ 12	2,600
12.196.18	3000	φ 14	3,600
12.196.19	3000	φ 16	4,650
12.196.20	3000	φ 20	7,250
12.196.21	3000	φ 24	10,250

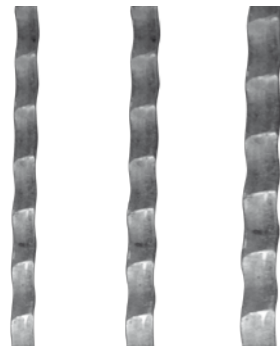

NR ART	H (mm)	□ (mm)	W (kg)
12.213	3000	□ 12 x 12	3,000
12.214	3000	□ 14 x 14	4,200
12.215	3000	□ 16 x 16	5,800

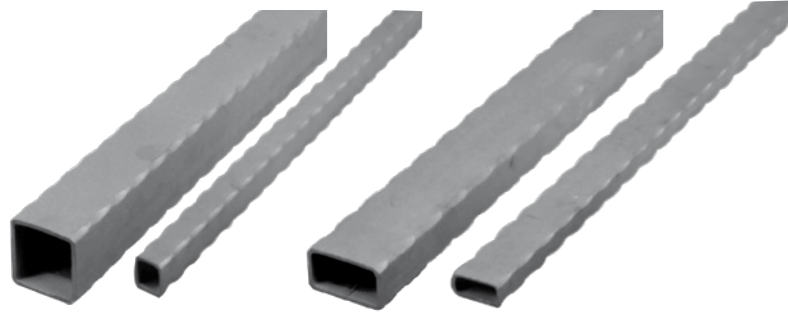

NR ART	H (mm)	□ (mm)	G (mm)	W (kg)
12.237	3000	□ 40 x 40	2,5	8,950
12.239	3000	□ 30 x 30	2,5	6,750
12.241	3000	□ 25 x 25	2,5	4,400
12.243	3000	□ 20 x 20	2,0	3,400
12.245	3000	□ 60 x 40	2,5	13,300
12.249	3000	□ 50 x 30	2,5	8,500
12.250.01	3000	□ 40 x 30	2,5	7,800
12.251	3000	□ 40 x 20	2,5	5,300
12.253	3000	□ 30 x 20	2,5	4,410

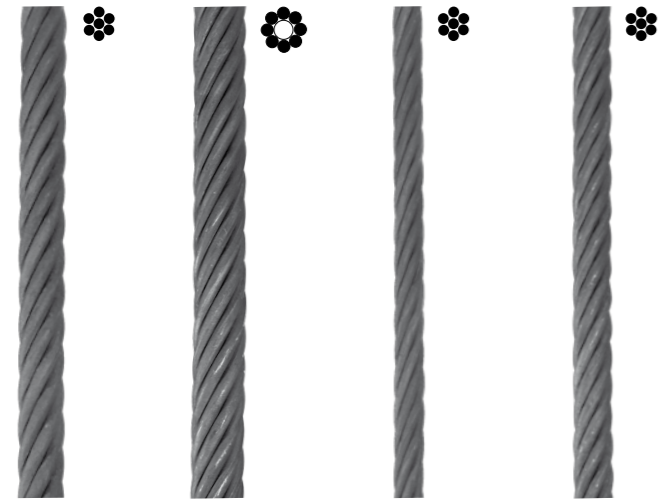

NR ART	H (mm)	φ (mm)	☼	W (kg)
12.305.11	1000	φ 38	6 x φ 12	6,650
12.305.12	2000	φ 38	6 x φ 12	13,300
12.305.13	3000	φ 38	6 x φ 12	19,950
12.305.21	1000	φ 47	8 x φ 12	9,100
12.305.22	2000	φ 47	8 x φ 12	18,200
12.305.23	3000	φ 47	8 x φ 12	27,300
12.305.31	1000	φ 25	6 x φ 8	2,860
12.305.32	2000	φ 25	6 x φ 8	5,720
12.305.33	3000	φ 25	6 x φ 8	8,580
12.305.41	1000	φ 30	6 x φ 10	4,720
12.305.42	2000	φ 30	6 x φ 10	9,440
12.305.43	3000	φ 30	6 x φ 10	14,160



NR ART	12.341	12.342	12.343	12.344	12.345	12.346	12.348	12.349
□ (mm)	□ 32 x 5	□ 31 x 5	□ 31 x 5	□ 31 x 5	□ 32 x 9	□ 31 x 5	□ 32 x 9	□ 32 x 6
H (mm)	3000	3000	3000	3000	3000	3000	3000	3000
W (kg)	3,650	2,900	3,270	3,200	3,900	3,150	5,900	3,700

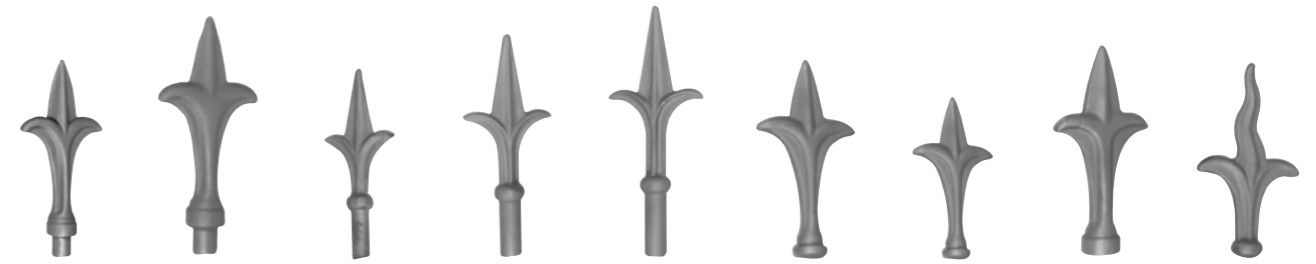

NR ART	13.041	13.042	13.045	13.046	13.047	13.048	13.048.01	13.049	13.050
H (mm)	125	155	130	160	200	110	76	135	130
L (mm)	60	70	50	65	85	60	43	70	70
φ (mm)	φ 13	φ 17	φ 13	φ 17	φ 20	φ 20	φ 16	φ 26	φ 20
W (kg)	0,140	0,280	0,130	0,230	0,330	0,120	0,064	0,260	0,130



NR ART	13.052	13.052.02	13.053	13.053.02	13.055	13.056	13.058	13.059	13.060
H (mm)	130	130	155	155	80	125	125	135	115
L (mm)	60	60	70	70	45	65	55	65	60
φ (mm)	φ 12	φ 12	φ 16	φ 16	φ 20	φ 25	φ 20	φ 25	φ 20
W (kg)	0,160	0,180	0,260	0,285	0,135	0,360	0,170	0,230	0,148

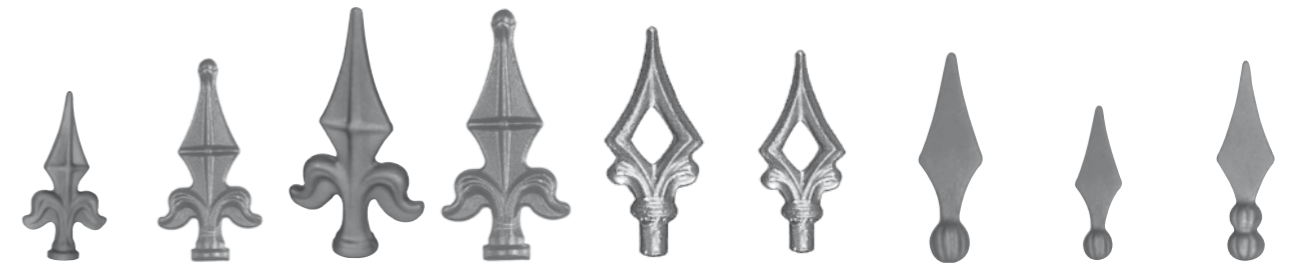

NR ART	13.060.01	13.060.02	13.061	13.061.02	13.064.01	13.064.02	13.071	13.071.01	13.072
H (mm)	78	115	140	140	120	100	125	95	135
L (mm)	43	60	70	70	55	45	40	30	40
φ (mm)	φ 16	φ 20	φ 26	φ 26	φ 14	φ 12	φ 25	φ 20	φ 25
W (kg)	0,083	0,170	0,260	0,280	0,260	0,130	0,160	0,096	0,170

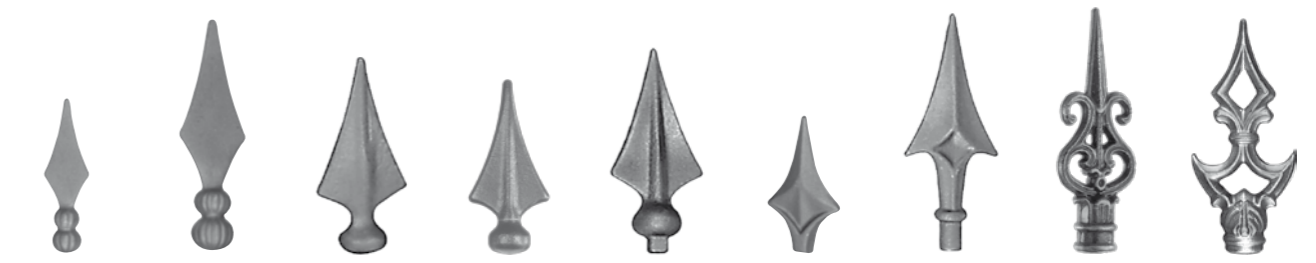

NR ART	13.072.01	13.073	13.077	13.077.01	13.078	13.079	13.080	13.080.02	13.080.06
H (mm)	95	160	125	110	140	100	155	145	130
L (mm)	33	50	60	50	60	50	65	58	70
φ / □ (mm)	φ 20	φ 30	φ 32	φ 25	□ 15	□ 16 x 12	φ 16	φ 28	φ 20
W (kg)	0,100	0,320	0,250	0,160	0,255	0,140	0,270	0,280	0,130



NR ART	13.089	13.092	13.092.01	13.093	13.094	13.095	13.097	13.098.01	13.098.02	13.098.03
H (mm)	160	125	82	160	190	95	60	150	120	88
L (mm)	25	30	20	40	50	27	30	40	35	28
φ / □ (mm)	25 x 25	20 x 20	15 x 15	32 x 32	40 x 40	12 x 12	24 x 24	φ 33	φ 30	φ 24
W (kg)	0,330	0,220	0,103	0,620	1,130	0,180	0,200	0,400	0,220	0,115

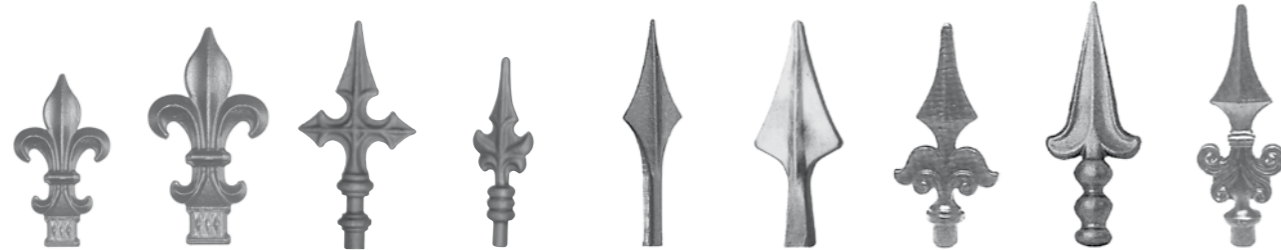

NR ART	13.099.01	13.099.02	13.100	13.102	13.103.01	13.103.02	13.103.03	13.103.04	13.103.05
H (mm)	120	155	160	140	180	155	150	165	150
L (mm)	65	90	90	50	56	60	65	60	55
φ / □ (mm)	□ 25	□ 30	φ 16	φ 13	φ 14	□ 14 - 18	φ 16	φ 24	φ 15
W (kg)	0,230	0,700	0,303	0,160	0,233	0,310	0,300	0,300	0,280



NR ART	13.107	13.110	13.111.01	13.117	13.118	13.127	13.128	13.218.01	13.222.07	13.222.08
H (mm)	145	235	210	180	205	130	135	57	250	250
L (mm)	80	80	58	60	65	33	30	38		
φ / □ (mm)	□ 15	φ 50	φ 32	φ 29	φ 35	φ 30	□ 30	□ 16	□ 12	□ 14
W (kg)	0,230	0,850	1,090	0,285	0,535	0,380	0,395	0,190	0,240	0,310



NR ART	13.401	13.407.01	13.407.02	13.407.03	13.410.01	13.410.02	13.411	13.411.01	13.413
H (mm)	120	142	112	87	152	180	120	120	120
L (mm)	48				φ 36	φ 41	40	40	42
φ / □ (mm)	□ 16	□ 26	□ 20	□ 16	φ 26	φ 43	□ 12	□ 12	□ 14 - 18
W (kg)	0,170	0,320	0,303	0,080	0,310	0,600	0,100	0,090	0,108

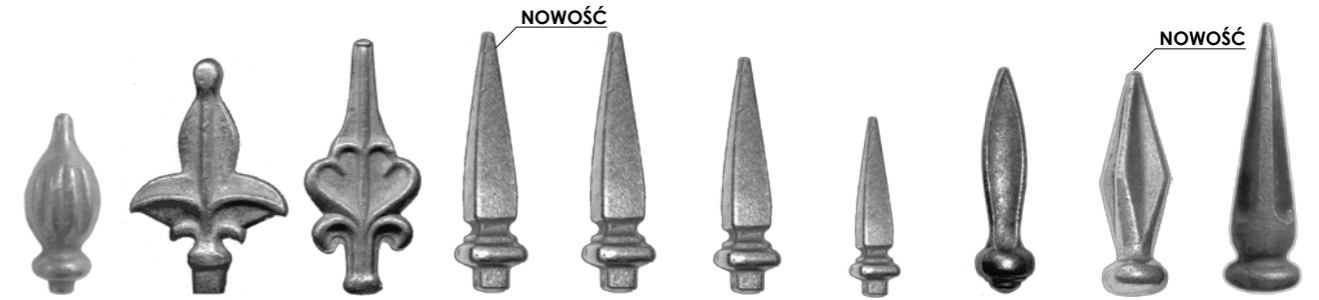

NR ART	13.414	13.416	13.419	13.421	13.421.01	13.421.02	13.421.03	13.424	13.427	13.433
H (mm)	92	132	155	148	148	142	107	118	117	145
L (mm)	φ 36	86	70	36	36	28	26	35	36	
φ / □ (mm)	φ 12	φ 16	φ 24	□ 16	□ 20	□ 16	□ 16	φ 32	φ 32	φ 35
W (kg)	0,360	0,300	0,360	0,480	0,480	0,340	0,200	0,310	0,34	0,430



NR ART	13.439	13.450	13.450.01	13.451	13.451.01	13.453	13.454	13.454.01	13.454.02
H (mm)	111	107	107	100	100	155	48	214	167
L (mm)	65	52	52	54	54	39	φ 33	36	33
φ / □ (mm)	φ 14	φ 28	φ 28	φ 16	φ 16	φ 36	φ 20	□ 18	□ 18
W (kg)	0,190	0,200	0,220	0,280	0,300	0,420	0,160	0,680	0,450



NR ART	H (mm)	L (mm)	φ / □ (mm)	W (kg)
13.133	39	40	bez otw.	0,200
13.135	39	40	φ 12,5	0,150
13.136	39	40	φ 14,5	0,140
13.141	39	40	□ 12	0,140
13.150	44	45	□ 14	0,200

NR ART	H (mm)	L (mm)	φ / □ (mm)	W (kg)
13.134	67	40	bez otw.	0,260
13.142	67	40	□ 12,5	0,180
13.147	67	45	φ 14,5	0,300
13.152	67	45	□ 14,5	0,275
13.153	67	45	□ 16,5	0,240



NR ART	H (mm)	L (mm)	φ / □ (mm)	W (kg)
13.168	22	40	φ 14,5	0,140
13.169	22	40	□ 14,5	0,115
13.169.01	22	40	□ 16,5	0,100
13.169.02	22	40	□ 12,5	0,120

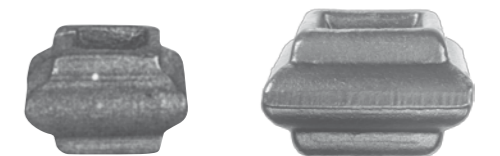

NR ART	H (mm)	L (mm)	φ / □ (mm)	W (kg)
13.169.03	22	33	□ 12,5	0,100
13.169.05	22	38	□ 14,5	0,160
13.169.06	22	38	□ 16,5	0,155
13.169.07	35	55	□ 20,5	0,345



NR ART	13.186.01	13.186.02	13.186.03	13.186.04	13.186.05	13.186.06	13.186.07	13.186.08	13.186.09	13.186.10
H (mm)	140	140	140	140	140	70	70	70	130	140
L (mm)	35	30	26	33	28	30	30	35	25	24
φ / □ (mm)	□ 20	□ 16	□ 12	φ 16-18	φ 12-14	φ 12-14	□ 10-12	□ 14-16	□ 14	φ 12
W (kg)	0,850	0,580	0,380	0,575	0,385	0,260	0,260	0,380	0,380	0,360



NR ART	13.214	13.217	13.217.01	13.218	13.219	13.220	13.227	13.229
H (mm)	90	90	150	180	80	100	130	120
φ / □ (mm)	φ 40	φ 50	φ 75	φ 100	φ 28	φ 50	φ 75	φ 75
W (kg)	0,500	0,780	3,060	6,350	0,410	0,900	1,880	1,890



NR ART	13.235.01	13.235.02	13.235.03	13.235.06	13.235.07	13.236	13.238	13.517
H x L (mm)	60	85	125	60	85	45	70	230 x 210
φ / □ (mm)	□ 25	□ 40	□ 60	φ 27	φ 42	φ 30	φ 55	φ 60
W (kg)	0,180	0,540	1,680	0,160	0,550	0,140	0,800	5,600

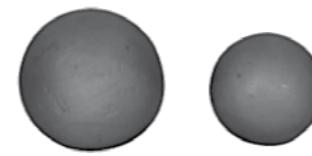

KULE PEŁNE		
NR ART	φ (mm)	W (kg)
13.240	15	0,017
13.241	20	0,032
13.242	25	0,064
13.243	30	0,116
13.244	35	0,186
13.245	40	0,260
13.246	50	0,510

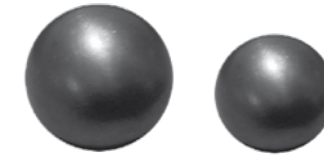

KULE PUSTE		
NR ART	φ (mm)	W (kg)
13.251.15	15	0,004
13.251.20	20	0,009
13.251.25	25	0,019
13.251.30	30	0,032
13.251.35	35	0,041
13.251.40	40	0,062
13.251.50	50	0,090
13.251.60	60	0,125
13.251.70	70	0,175
13.251.80	80	0,245
13.251.90	90	0,350
13.251.100	100	0,400
13.251.120	120	0,725
13.251.150	150	1,100

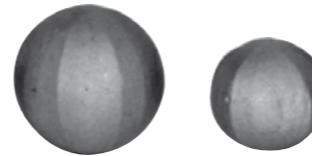

NR ART	φ (mm)	W (kg)
13.258	20	0,032
13.259	25	0,064
13.260	30	0,111
13.261	35	0,180
13.262	40	0,300
13.263	50	0,520
13.264	60	0,860



NR ART	φ (mm)	W (kg)
13.450.22	22	0,030
13.450.32	32	0,115
13.450.40	40	0,250
13.450.50	50	0,500



NR ART	13.303	13.305	13.306	13.310.01	13.310.02	13.310.03	13.310.05
H x L (mm)	90 x 90	70 x 70	50 x 50	120 x 50	148 x 60	200 x 85	250 x 130
□ (mm)	□ 26	□ 21	□ 12				
G (mm)	8	8	6	4	4	4	4
W (kg)	0,450	0,278	0,105	0,100	0,140	0,310	0,580

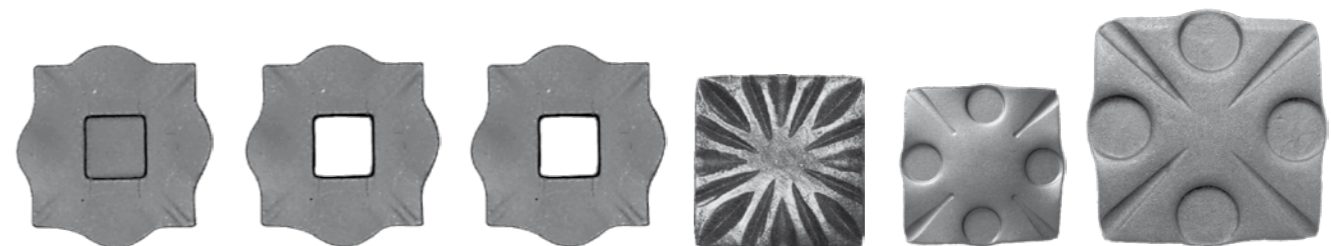

NR ART	13.311	13.312	13.313	13.314.19	13.432.01	13.432.02
H x L (mm)	100 x 100	100 x 100	100 x 100	85 x 85	80 x 80	120 x 120
□ (mm)	bez otw.	□ 25	□ 30			7
G (mm)	10	10	10	10	7	0,380
W (kg)	0,465	0,380	0,360	0,390	0,400	0,800

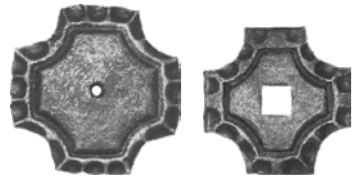

NR ART	H x L (mm)	□ (mm)	W (kg)
13.313.11	65 x 65	bez otw.	0,100
13.313.12	75 x 75	bez otw.	0,150
13.315.12	65 x 65	□ 12	0,100
13.316.16	75 x 75	□ 16	0,160
13.316.20	75 x 75	□ 20	0,150
13.316.25	75 x 75	□ 25	0,140

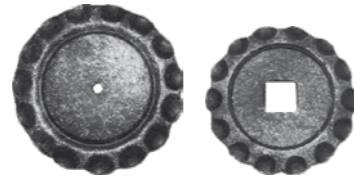

NR ART	H x L (mm)	□ (mm)	W (kg)
13.313.13	65 x 65	bez otw.	0,110
13.313.14	75 x 75	bez otw.	0,160
13.317.12	65 x 65	□ 12	0,100
13.318.16	75 x 75	□ 16	0,140
13.318.20	75 x 75	□ 20	0,130
13.318.25	75 x 75	□ 25	0,120

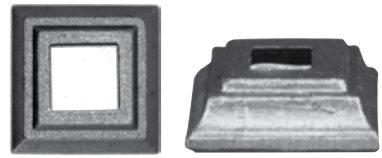

NR ART	H x L (mm)	□ (mm)	W (kg)
13.319	80 x 80	□ 30,5	0,280
13.321	80 x 80	□ 40,5	0,280
13.322	60 x 60	□ 25,5	0,180
13.323	60 x 60	□ 30,5	0,180
13.326	50 x 50	□ 20,5	0,110
13.327	40 x 40	□ 12,5	0,070
13.328	40 x 40	□ 14,5	0,070
13.329	40 x 40	□ 16,5	0,070



NR ART	H (mm)	φ (mm)	W (kg)
13.333	20	φ 80	0,230
13.334	20	φ 60	0,140
13.336	20	φ 40	0,050



NR ART	H x L (mm)	□ (mm)	W (kg)
13.435.20	75 x 75	□ 20	0,190
13.435.25	75 x 75	□ 25	0,180
13.435.30	75 x 75	□ 30	0,170
13.435.40	75 x 75	□ 40	0,160
13.435.42	75 x 75	□ 40 x 20	0,180
13.436.12	50 x 50	□ 12	0,100
13.436.14	50 x 50	□ 14	0,090
13.436.16	50 x 50	□ 16	0,080
13.436.20	50 x 50	□ 20	0,070

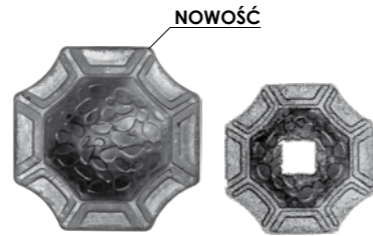

NR ART	H (mm)	□ (mm)	G (mm)
13.440.01	100 x 100	bez otw.	2,5
13.440.02	78 x 78	bez otw.	2,5
13.441.12	78 x 78	□ 12	2,5
13.441.14	78 x 78	□ 14	2,5
13.441.16	78 x 78	□ 16	2,5
13.441.20	100 x 100	□ 20	2,5
13.441.25	100 x 100	□ 25	2,5
13.441.30	100 x 100	□ 30	2,5
13.441.40	100 x 100	□ 40	2,5



NR ART	13.433.01	13.433.02	13.434	13.440	13.547	13.550	13.553
H x L (mm)	80 x 80	120 x 120	120 x 120	60 x 60	154	160 x 105	135 x 35
G (mm)	7	7	7	8		6	
W (kg)	0,400	0,800	0,800	0,150	0,180	0,450	0,210

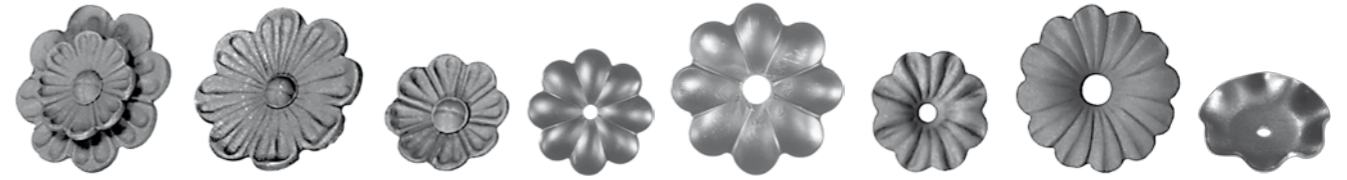

NR ART	14.001	14.003	14.004	14.005.06	14.005.07	14.014	14.015	14.017
φ (mm)	φ 95	φ 95	φ 62	φ 60	φ 90	φ 60	φ 95	φ 50
G (mm)	5	5	4	2	2	3	3	1
W (kg)	0,320	0,250	0,145	0,005	0,100	0,080	0,160	0,240

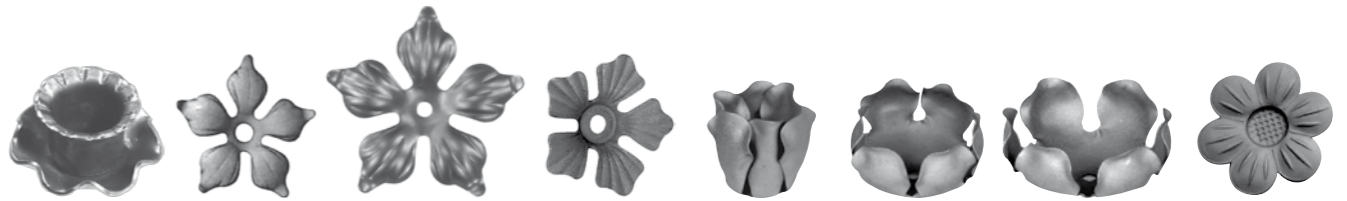

NR ART	14.017.01	14.021	14.021.01	14.022	14.024	14.025	14.026	14.027.01
H (mm)	20				40	35	30	
φ (mm)	φ 50	φ 90	φ 135	φ 86	φ 40	φ 55	φ 65	φ 60
G (mm)	1	2	2	2	0,5	0,5	0,5	2
W (kg)	0,044	0,060	0,160	0,060	0,018	0,019	0,210	0,036

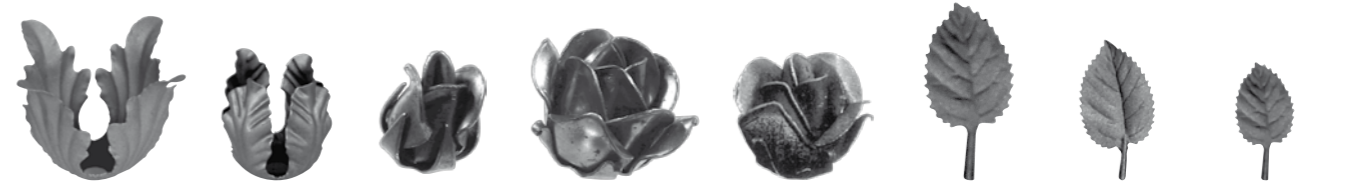

NR ART	14.027	14.030	14.035.02	14.035.03	14.035.12	14.037	14.038	14.038.01
H x L (mm)	70	42	43	48	45	85 x 45	70 x 35	60 x 28
φ (mm)	φ 90	φ 40	φ 35	φ 60	φ 45			
G (mm)	0,6	0,6	1,5	1,5	1,5	0,5	0,5	0,5
W (kg)	0,035	0,016	0,053	0,120	0,080	0,010	0,006	0,004

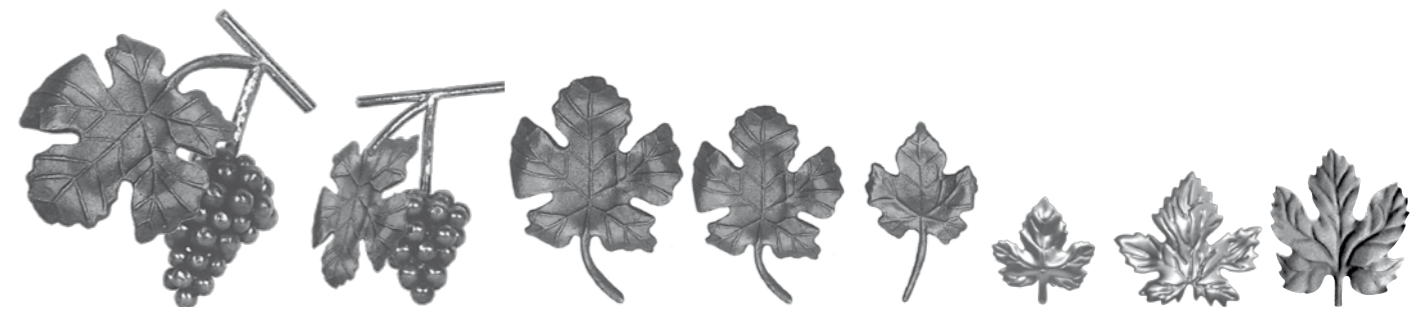

NR ART	14.039.04	14.039.05	14.039.10	14.039.11	14.039.14	14.040	14.041	14.042
H x L (mm)	200 x 140	150 x 100	155 x 110	135 x 85	125 x 75	57 x 55	75 x 70	105 x 95
G (mm)						0,6	0,6	0,6
W (kg)	1,220	0,720	0,320	0,200	0,138	0,006	0,010	0,039



NR ART	14.059	14.060	14.061	14.062	14.063	14.064	14.069	14.070	14.073	14.074
H x L (mm)	155 x 60	155 x 60	110 x 40	110 x 40	90 x 30	90 x 30	80 x 60	80 x 60	55 x 70	55 x 70
W (kg)	0,110	0,110	0,065	0,065	0,036	0,036	0,060	0,060	0,046	0,046



NR ART	14.077	14.078	14.078.02	14.078.04	14.081	14.083.02	14.083.03	14.083.05	14.083.06	14.083.07
H x L (mm)	110 x 75	110 x 75	185 x 100	280 x 50	165 x 75	∅ 90	∅ 55	∅ 120	∅ 90	∅ 50
W (kg)	0,089	0,089	0,320	0,240	0,200	0,240	0,081	0,980	0,430	0,100



NR ART	14.084.01	14.084.02	14.084.03	14.084.04	14.084.05	14.084.06	14.085.01	14.085	14.086
H x L (mm)	80 x 70	∅ 100	135 x 85	115 x 100	135 x 85	115 x 100	150 x 40	330 x 260	190 x 125
G (mm)	3	3	3	3	3	3			
W (kg)	0,084	0,116	0,100	0,110	0,100	0,110	0,130	1,300	0,400



NR ART	14.087	14.087.06	14.087.08	14.087.13	14.087.14	14.087.15	14.087.16
H x L (mm)	130 x 75	90 x 55	225 x 60	140 x 110	140 x 110	190 x 160	190 x 160
G (mm)		4	4				
W (kg)	0,110	0,100	0,200	0,180	0,180	0,400	0,400

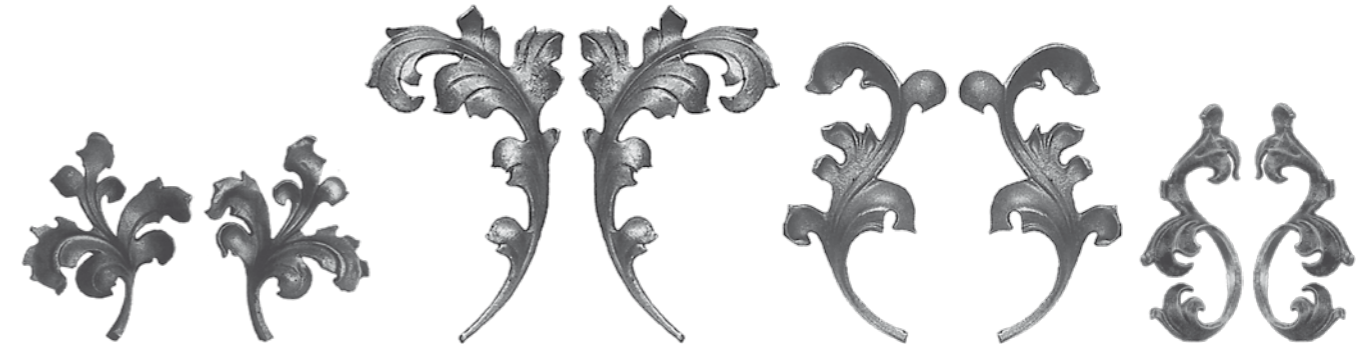

NR ART	14.087.17	14.087.18	14.087.19	14.087.20	14.087.21	14.087.22	14.087.23	14.087.24
H x L (mm)	155 x 140	155 x 140	250 x 150	250 x 150	220 x 105	220 x 105	180 x 85	180 x 85
W (kg)	0,280	0,280	0,460	0,460	0,290	0,290	0,230	0,230



NR ART	14.087.25	14.087.26	14.087.27	14.087.28	14.087.29	14.087.30
H x L (mm)	180 x 115	180 x 115	234 x 104	230 x 130	230 x 130	160 x 160
W (kg)	0,250	0,250	0,320	0,320	0,320	0,330



NR ART	14.087.31	14.087.32	14.241.13	14.241.14	14.242.01	14.242.02	14.242.07	14.242.08
H x L (mm)	∅ 90 x 60	∅ 90	125 x 52	125 x 52	80 x 45	80 x 45	225 x 130	225 x 130
W (kg)	0,180	0,120	0,100	0,100	0,040	0,040	0,650	0,650



NR ART	14.243.14	14.243.17	14.243.18	14.243.20	14.245.10	14.245.12
H x L (mm)	95 x 80	∅ 70	∅ 90	75 x 90	∅ 90	∅ 120
W (kg)	0,120	0,110	0,300	0,280	0,170	0,480



NR ART	14.248.05	14.291.05	14.292.12	14.292.13	14.292.14	14.292.15
H x L (mm)	410 x 70	135 x 110	115 x 105	115 x 105	175 x 110	175 x 110
φ (mm)	φ 6	φ 14				
W (kg)	2,200	0,340	0,170	0,170	0,320	0,320



NR ART	14.301.01	14.301.02	14.301.03	14.301.04	14.301.05	14.301.06	14.301.07	14.301.08
H x L (mm)	450 x 160	240 x 140	70 x 50	50 x 40	200 x 205	130 x 130	550 x 370	210 x 105
G (mm)			2	2	2	2		
W (kg)	0,540	0,220	0,040	0,020	0,140	0,080	5,260	0,140



NR ART	14.301.11	14.301.12	14.301.13	14.301.14	14.301.21	14.301.22	14.301.28	14.302.01	14.302.02	14.302.03
H x L (mm)	75 x 50	75 x 50	55 x 40	55 x 40	70 x 60	40 x 45	40 x 30	110	80	65
W (kg)	0,045	0,045	0,020	0,020	0,320	0,140	0,060	1,340	0,740	0,360



NR ART	14.302.04	14.302.05	14.302.06	14.302.07	14.302.08	14.302.09
H x L (mm)	150 x 140	125 x 115	95 x 90	75 x 70	450 x 380	450 x 380
W (kg)	0,260	0,140	0,080	0,040	5,240	5,240

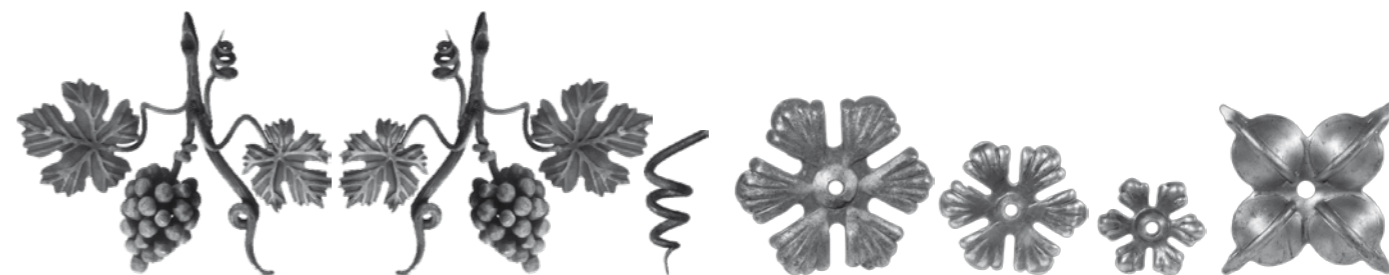

NR ART	14.302.10	14.302.11	14.302.13	14.303.01	14.303.02	14.303.03	14.303.04
H x L (mm)	250 x 300	250 x 300	70	φ 120	φ 90	φ 65	115 x 115
G (mm)				3	3	3	1,5
W (kg)	1,880	1,880	0,050	0,180	0,120	0,060	0,060

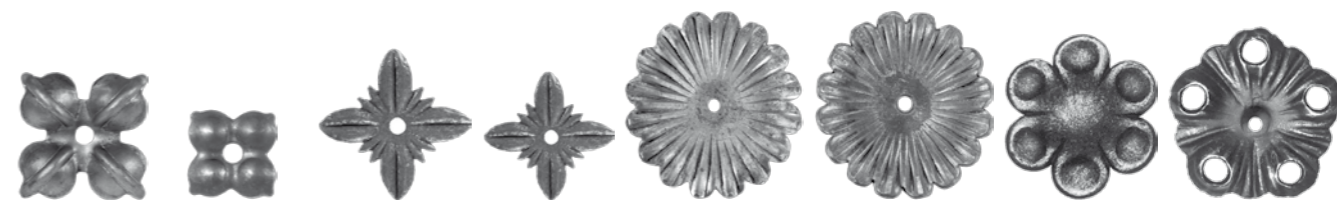

NR ART	14.303.05	14.303.06	14.303.07	14.303.08	14.303.09	14.303.10	14.303.14	14.303.15
H x L (mm)	70 x 70	45 x 45	80 x 80	60 x 60	φ 115	φ 115	φ 95	φ 100
G (mm)	1,5	1,5	1,5	1,5	4	4	5	4
W (kg)	0,040	0,020	0,028	0,016	0,320	0,320	0,260	0,180

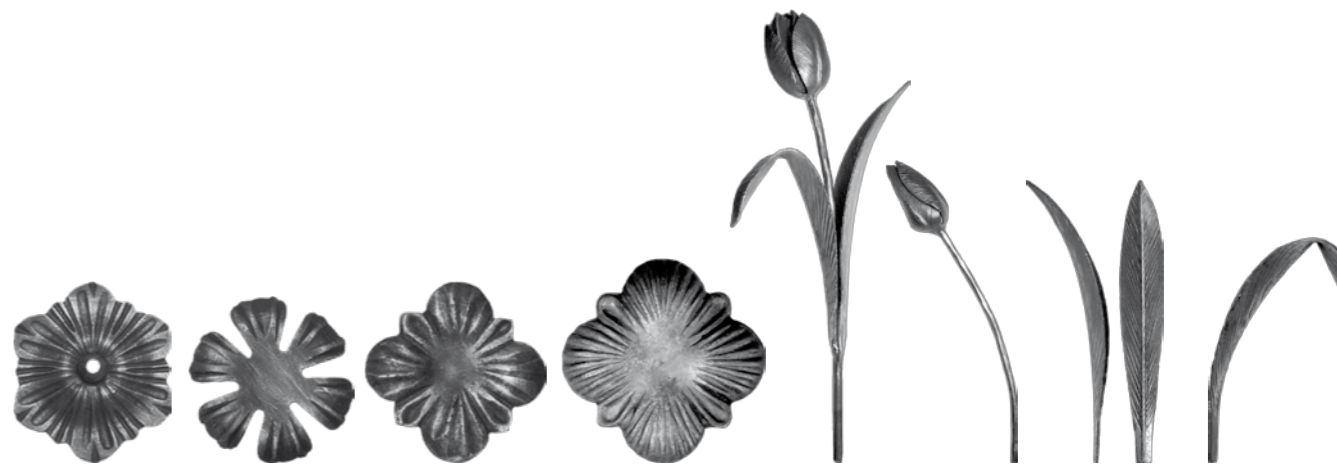

NR ART	14.303.16	14.303.17	14.303.18	14.303.20	14.303.21	14.303.22	14.303.23	14.303.24
H x L (mm)	120	110	120	150	410 x 165	275 x 105	250 x 45	160 x 110
G (mm)	4	5	5	5			2	2
W (kg)	0,270	0,210	0,340	0,550				



NR ART	14.304.01	14.304.02	14.304.03	14.304.04	14.304.05	14.304.06
H x L (mm)	55 x 90	55 x 90	85 x 85	85 x 85	70 x 110	70 x 110
G (mm)	4	4	4	4	4	4
W (kg)	0,100	0,100	0,140	0,140	0,150	0,150



NR ART	14.304.07	14.304.08	14.304.11	14.304.12	14.304.13	14.304.14
H x L (mm)	140 x 105	140 x 105	110 x 85	110 x 85	90 x 100	90 x 100
G (mm)	4	4	3	3	3	3
W (kg)	0,310	0,310	0,120	0,120	0,130	0,130



NR ART	14.304.15	14.304.16	14.304.17	14.304.18	14.304.19	14.304.20
H x L (mm)	60 x 80	60 x 80	80 x 150	165 x 60	105 x 95	105 x 95
G (mm)	3	3	1,5	3	3	3
W (kg)	0,060	0,060	0,200	0,300	0,100	0,100



NR ART	14.304.21	14.304.22	14.304.23	14.304.24	14.304.25	14.304.26	14.304.31	14.304.32
H x L (mm)	85 x 125	85 x 125	125 x 85	125 x 85	150 x 135	150 x 135	130 x 70	130 x 70
G (mm)	3	3	3	3	4	4	4	4
W (kg)	0,200	0,200	0,100	0,100	0,260	0,260	0,160	0,160



NR ART	14.304.33	14.304.34	14.304.41	14.304.42	14.304.43	14.304.44
H x L (mm)	160 x 205	160 x 250	235 x 230	210 x 180	140 x 110	85 x 45
G (mm)	4	4	2,5	2,5	2,5	5
W (kg)	0,580	0,580	0,540	0,380	0,130	0,060



NR ART	14.305.01	14.305.02	14.305.12	14.305.13	14.305.14	14.305.15	14.305.16	14.305.18	14.305.20
H x L (mm)	115 x 125	115 x 125	155 x 90	240 x 65	225 x 115	85 x 75	75 x 175	240 x 60	220 x 45
G (mm)	4	4	4	4	4	2,5	2,5	4	4
W (kg)	0,210	0,210	0,190	0,250	0,340	0,170	0,170	0,190	0,120



NR ART	14.305.21	14.305.22	14.305.30	14.305.31	14.305.36	14.305.37
H x L (mm)	115 x 200	90 x 145	350 x 315	350 x 315	270 x 250	270 x 250
G (mm)	2	2				
W (kg)	0,260	0,140				



NR ART	14.305.41	14.305.42	14.305.43	14.305.44	14.305.45	14.306.01	14.306.02	14.306.03	14.306.04
H x L (mm)	260 x 75	240 x 85	240 x 85	255 x 70	235 x 85	∅ 115 x 35	195 x 130	155 x 105	115 x 75
G (mm)	2	2	2	2	2		2	2	2
W (kg)	0,280	0,250	0,250	0,260	0,240	0,320	0,260	0,150	0,080

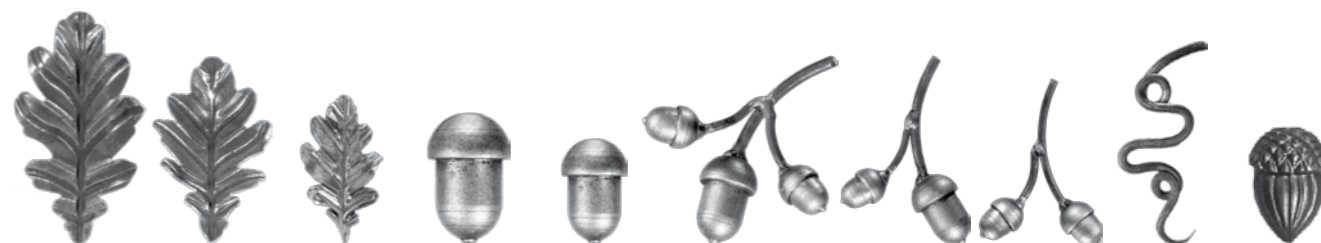

NR ART	14.307.01	14.307.02	14.307.03	14.307.04	14.307.05	14.307.06	14.307.07	14.307.08	14.307.09	14.307.54
H x L (mm)	170 x 95	140 x 75	100 x 55	35	28	85	65	60	117 x 52	65 x 45
W (kg)	0,160	0,100	0,040	0,080	0,040	0,200	0,160	0,120	0,080	0,060



NR ART	14.308.01	14.308.02	14.308.03	14.308.07	14.308.08	14.308.09	14.308.10	14.308.11	14.308.12
H x L (mm)	130 x 45	115 x 45	95 x 30	340 x 210	340 x 210	330 x 150	330 x 150	330 x 165	330 x 165
G (mm)	3	3	3						
W (kg)	0,080	0,060	0,040	0,800	0,800	0,480	0,480	0,380	0,380



NR ART	14.309.01	14.309.02	14.309.03	14.309.04	14.309.05	14.309.06	14.309.08	14.309.09	14.310.01	14.310.02
H x L (mm)	225 x 60	210 x 135	210 x 135	210 x 75	200 x 110	200 x 110	500	305	∅ 115 x 55	∅ 90 x 40
G (mm)							2	2		
W (kg)	0,300	0,280	0,280	0,400	0,440	0,440	0,250	0,250	0,560	0,360

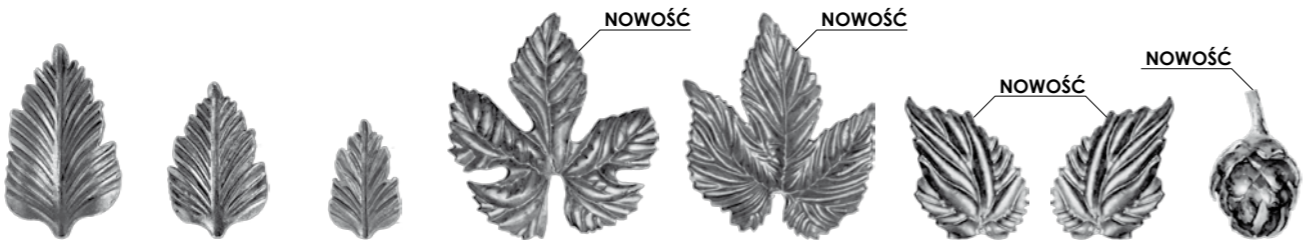

NR ART	14.310.03	14.310.04	14.310.05	14.311.01	14.311.02	14.311.03	14.311.04	14.311.05
H x L (mm)	145 x 90	115 x 70	85 x 50	170 x 160	170 x 145	105 x 65	105 x 65	50 x 40
G (mm)	4	4	4					
W (kg)	0,280	0,170	0,100					



NR ART	14.312.01	14.312.02	14.312.03	14.312.05	14.312.11	14.312.12	14.312.51
H x L (mm)	90 x 70	80 x 60	70 x 55	500 x 100	200 x 240	200 x 240	155 x 145

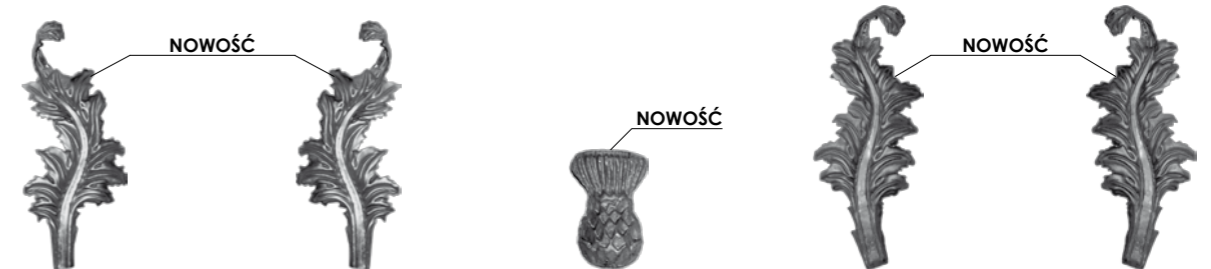

NR ART	14.313.01	14.313.02	14.312.03	14.313.11	14.313.12
H x L (mm)	335 x 145	335 x 145	80 x 55	345 x 140	345 x 140



NR ART	14.314.01	14.314.02	14.314.03	14.314.04	14.314.05	14.314.06	14.314.07	14.314.08
H x L (mm)	230 x 240	210 x 210	185 x 175	160 x 150	∅ 40	∅ 40	70 x 60	140 x 110
G (mm)	3	3	3	3				
W (kg)	0,860	0,650	0,540	0,400	0,100	0,140	0,060	0,160



NR ART	14.315.01	14.315.10	14.315.02	14.315.11	14.315.03	14.315.12	14.315.04	14.315.05	14.315.06
H x L (mm)	115 x 190	85 x 140	125 x 140	90 x 100	130 x 50	100 x 40	115 x 45	85 x 40	65 x 30
G (mm)							3	3	3
W (kg)	0,760	0,480	0,660	0,480	0,300	0,260	0,110	0,080	0,050



NR ART	14.315.07	14.317.01	14.317.02	14.317.03	14.317.04	14.317.05	14.441	14.442
H x L (mm)	420	110 x 130	95 x 110	60 x 70	70	55	∅ 105	∅ 74
G (mm)		2,5	2,5	2,5			5	6
W (kg)	2,120	0,160	0,100	0,040	0,240	0,140	0,330	0,23



NR ART	14.450	14.451	14.466.01	14.466.02	14.501.01	14.501.02	14.502.01	14.502.02
H x L (mm)	∅ 85	∅ 60	92	119	160 x 85	160 x 85	190 x 75	190 x 75
G (mm)	2,5	2,5						
W (kg)	0,150	0,080	0,100	0,160	0,120	0,120	0,100	0,100



NR ART	14.503.01	14.503.02	14.506	14.510.01	14.510.02	14.511.01	14.511.02	14.550	14.552
H x L (mm)	90 x 60	90 x 60	100 x 72	125 x 50	125 x 50	107 x 62	107 x 62	∅ 50	∅ 52
G (mm)				2,5	2,5	2,5	2,5		2,5
W (kg)	0,070	0,070	0,080	0,050	0,050	0,040	0,040	0,040	0,050

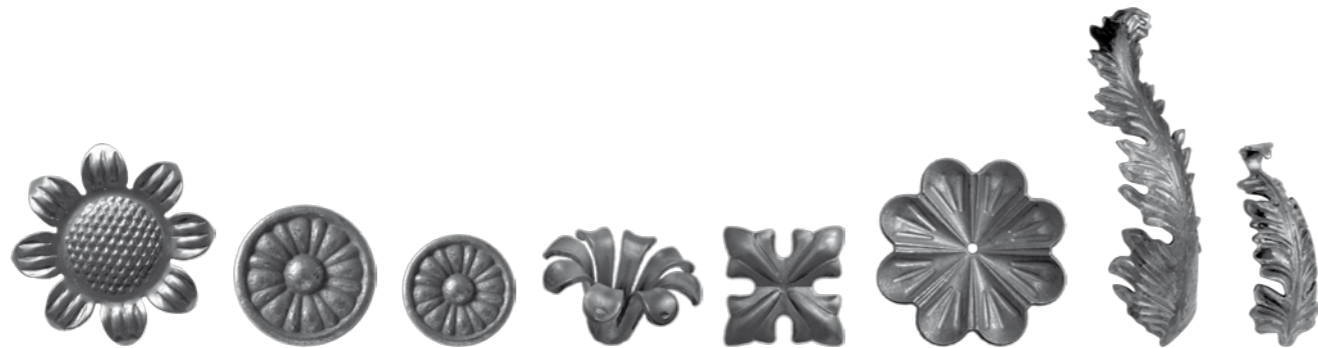

NR ART	14.556	14.563.01	14.563.02	14.565	14.566	14.567	14.692.08	14.692.09
H x L (mm)	∅ 135	∅ 64	∅ 46	∅ 52 x 33	44 x 44	∅ 122	330 x 100	180 x 50
G (mm)		6	5	2,5	2,5	4	4	4
W (kg)	0,170	0,200	0,160	0,040	0,250	0,320	0,975	0,290

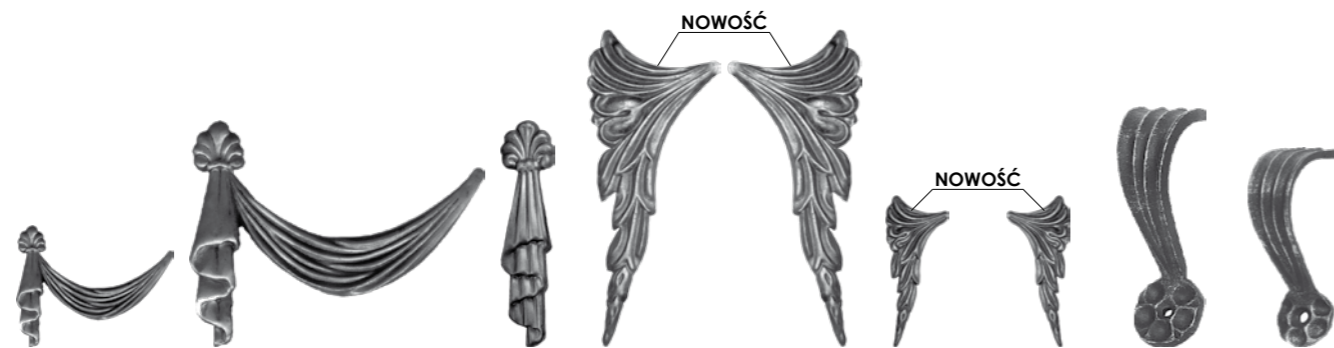

NR ART	14.704.02	14.704.03	14.704.04	14.705.01	14.705.02	14.705.03	14.705.04	15.365.01	15.365.02
H x L (mm)	115 x 155	225 x 305	225	300 x 120	300 x 120	90 x 85	90 x 85	150 x 55	110 x 40
G (mm)	1,5	1,5	1,5					8	8
W (kg)	0,160	0,040	0,250					0,500	0,300

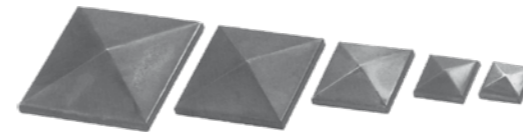

NR ART	□ (mm)	W (kg)
15.053	□ 40 x 40	0,045
15.054	□ 50 x 50	0,065
15.055	□ 60 x 60	0,080
15.056	□ 80 x 80	0,135
15.057	□ 100 x 100	0,195
15.058	□ 120 x 120	0,260

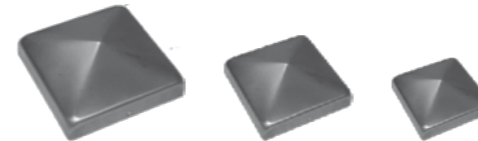

NR ART	□ (mm)	W (kg)
15.040	□ 40 x 40	0,040
15.050	□ 50 x 50	0,043
15.060	□ 60 x 60	0,061
15.070	□ 70 x 70	0,076
15.080	□ 80 x 80	0,096
15.090	□ 90 x 90	0,104
15.100	□ 100 x 100	0,110
15.120	□ 120 x 120	0,134

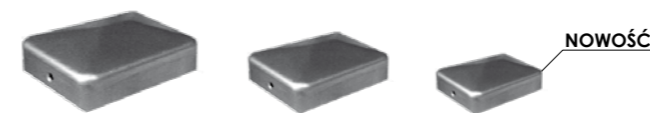

NR ART	□ (mm)	W (kg)
15.050.30	□ 50 x 30	0,035
15.060.40	□ 60 x 40	0,045
15.080.40	□ 80 x 40	0,051



NR ART	∅ (mm)	W (kg)
15.142	∅ 42 (1 1/4")	0,035
15.148	∅ 48 (1 1/2")	0,045
15.160	∅ 60 (2")	0,068
15.172	∅ 72	0,095
15.177	∅ 77 (2 1/2")	0,101
15.180	∅ 80	0,112
15.190	∅ 90	0,122
15.200	∅ 100	0,176
15.220	∅ 120	0,180



NR ART	□ (mm)	H (mm)	W (kg)
15.291.60	∅ 60	15	0,052
15.291.90	∅ 90	20	0,125

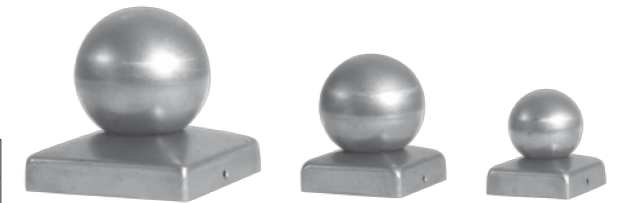

NR ART	□ (mm)	∅ KULI (mm)	W (kg)
15.040.40	□ 40 x 40	∅ 40	0,083
15.040.60	□ 40 x 40	∅ 60	0,152
15.050.40	□ 50 x 50	∅ 40	0,101
15.050.50	□ 50 x 50	∅ 50	0,120
15.060.50	□ 60 x 60	∅ 50	0,120
15.060.60	□ 60 x 60	∅ 60	0,175
15.060.80	□ 60 x 60	∅ 80	0,280
15.070.60	□ 70 x 70	∅ 60	0,195
15.070.70	□ 70 x 70	∅ 70	0,210
15.080.60	□ 80 x 80	∅ 60	0,220
15.080.70	□ 80 x 80	∅ 70	0,255
15.080.80	□ 80 x 80	∅ 80	0,320
15.080.100	□ 80 x 80	∅ 100	0,445
15.090.80	□ 90 x 90	∅ 80	0,335
15.090.90	□ 90 x 90	∅ 90	0,395
15.100.60	□ 100 x 100	∅ 60	0,245
15.100.80	□ 100 x 100	∅ 80	0,360
15.100.100	□ 100 x 100	∅ 100	0,465
15.120.80	□ 120 x 120	∅ 80	0,415
15.120.100	□ 120 x 120	∅ 100	0,520
15.120.120	□ 120 x 120	∅ 120	0,855

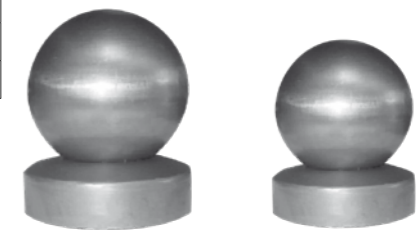

NR ART	∅ (mm)	∅ KULI (mm)	W (kg)
15.142.40	∅ 42 (1 1/4")	∅ 40	0,123
15.142.50	∅ 42 (1 1/4")	∅ 50	0,130
15.148.50	∅ 48 (1 1/2")	∅ 50	0,145
15.148.60	∅ 48 (1 1/2")	∅ 60	0,152
15.160.60	∅ 60 (2")	∅ 60	0,185
15.160.80	∅ 60 (2")	∅ 80	0,185
15.172.70	∅ 72	∅ 70	0,285
15.172.80	∅ 72	∅ 80	0,303
15.177.60	∅ 77 (2 1/2")	∅ 60	0,300
15.177.80	∅ 77 (2 1/2")	∅ 80	0,320
15.180.60	∅ 80	∅ 60	0,235
15.180.80	∅ 80	∅ 80	0,245
15.190.90	∅ 90	∅ 90	0,389
15.200.80	∅ 100	∅ 80	0,365
15.200.100	∅ 100	∅ 100	0,410

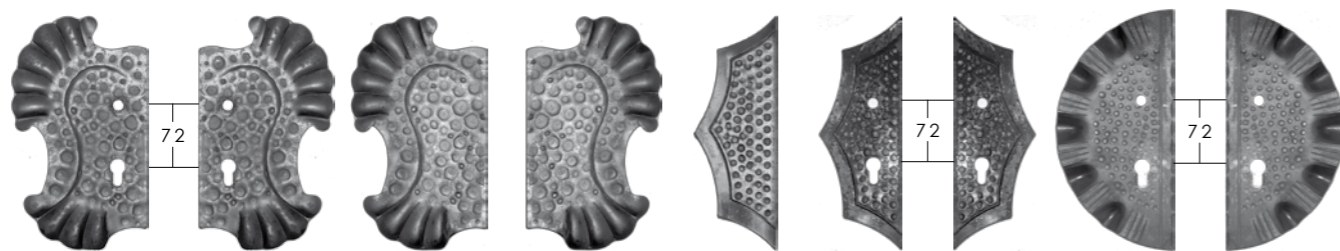

NR ART	15.042	15.043	15.042.01	15.043.01	15.271.01	15.271.03	15.271.04	15.272.01	15.272.02
H x L (mm)	270 x 160	270 x 160	270 x 160	270 x 160	275 x 95	275 x 95	275 x 95	263 x 128	263 x 128
G (mm)	3	3	3	3	5	5	5	3	3
W (kg)	0,800	0,800	0,800	0,800	0,540	0,540	0,540	0,570	0,570

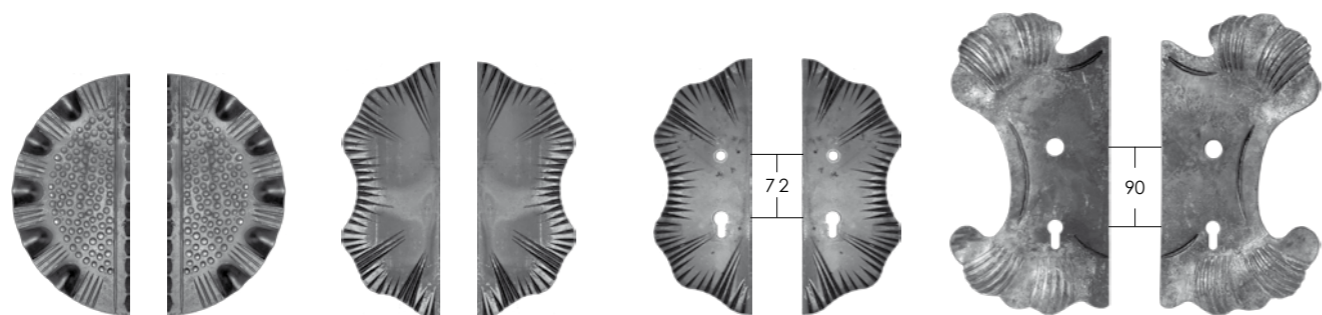

NR ART	15.272.05	15.272.06	15.273.41	15.273.42	15.273.51	15.273.52	15.361.01	15.361.02
H x L (mm)	263 x 128	263 x 128	285 x 105	285 x 105	285 x 105	285 x 105	330 x 180	330 x 180
G (mm)	3	3	5	5	5	5	4	4
W (kg)	0,570	0,570	0,800	0,800	0,800	0,800	1,360	1,360

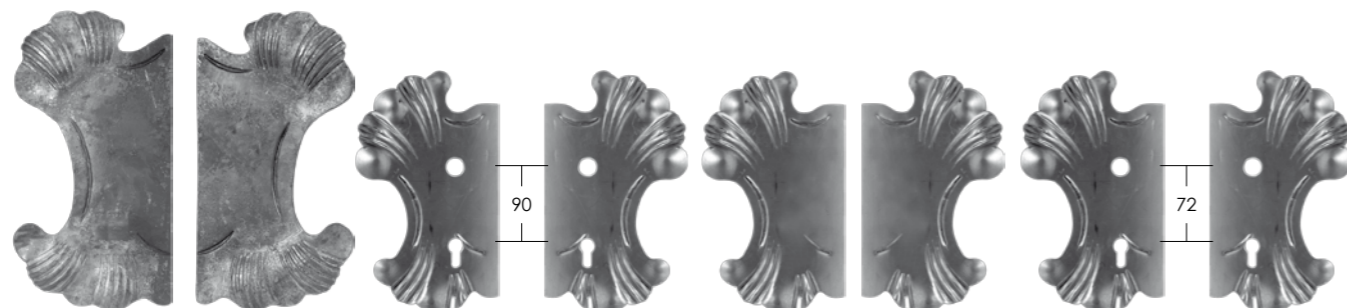

NR ART	15.361.03	15.361.04	15.362.01	15.362.02	15.362.03	15.362.04	15.362.05	15.362.06
H x L (mm)	330 x 180	330 x 180	270 x 165	270 x 165	270 x 165	270 x 165	270 x 165	270 x 165
G (mm)	4	4	2,5	2,5	2,5	2,5	2,5	2,5
W (kg)	1,360	1,360	0,600	0,600	0,600	0,600	0,600	0,600

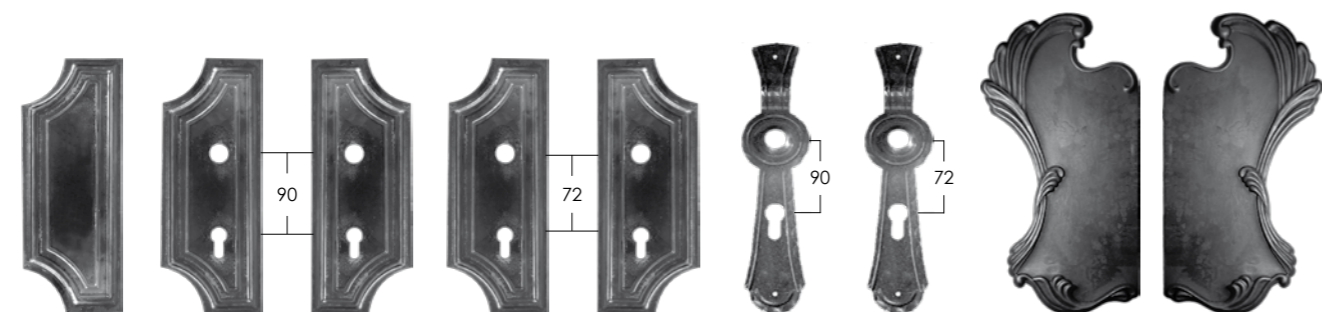

NR ART	15.363	15.363.01	15.363.02	15.363.03	15.363.04	15.364	15.364.04	15.365.11	15.365.12
H x L (mm)	280 x 110	280 x 110	280 x 110	280 x 110	280 x 110	275 x 65	275 x 65	330 x 175	330 x 175
G (mm)	3	3	3	3	3	3	3	3	3
W (kg)	0,660	0,600	0,600	0,600	0,600	0,260	0,260	0,920	0,920

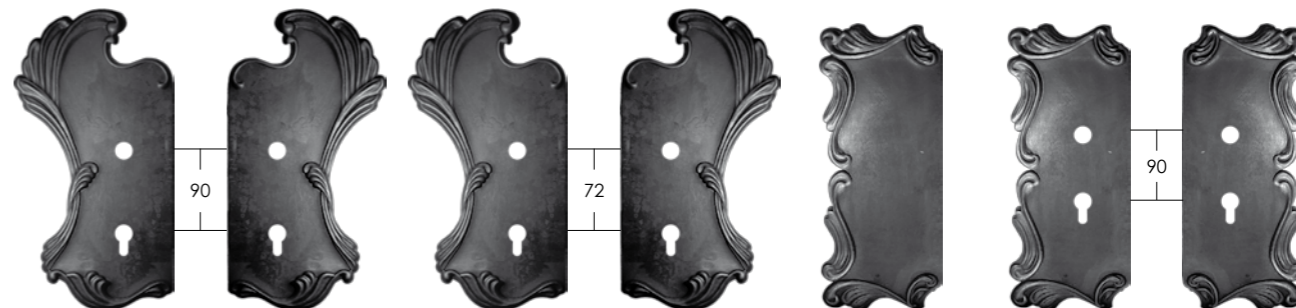

NR ART	15.365.13	15.365.14	15.365.15	15.365.16	15.366	15.366.01	15.366.02
H x L (mm)	330 x 175	330 x 175	330 x 175	330 x 175	315 x 135	315 x 135	315 x 135
G (mm)	3	3	3	3	3	3	3
W (kg)	0,920	0,920	0,920	0,920	0,900	0,900	0,900

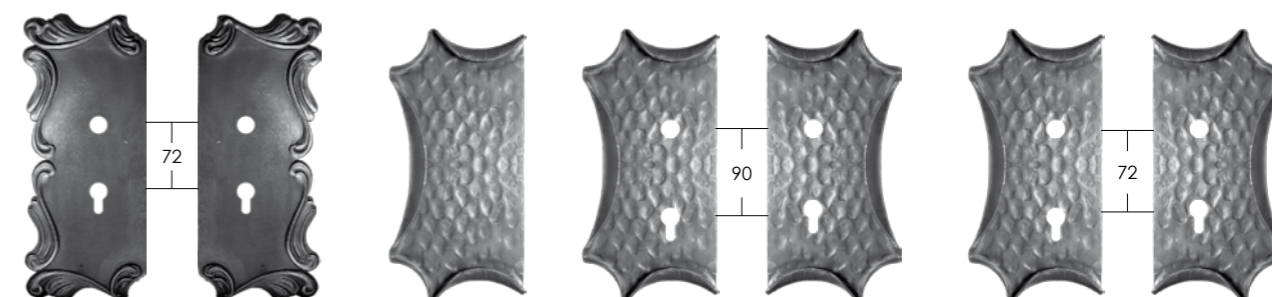

NR ART	15.366.03	15.366.04	15.367	15.367.01	15.367.02	15.367.03	15.367.04
H x L (mm)	315 x 135	315 x 135	280 x 140	280 x 140	280 x 140	280 x 140	280 x 140
G (mm)	3	3	4	4	4	4	4
W (kg)	0,900	0,900	0,800	0,800	0,800	0,800	0,800



NR ART	15.270.06	15.270.08	15.270.09	15.270.10	15.364.01	15.364.02	15.460.01	15.460.02
φ / H (mm)	φ 65	φ 65	φ 50	φ 50	φ 50	φ 50	φ 35	55 x 35
G (mm)	2	2	2	2	5	5	2,5	2,5
W (kg)	0,040	0,040	0,030	0,030	0,050	0,050	0,030	0,050



NR ART	15.250.07	15.250.08	15.250.16	15.250.18	15.401	15.402
H x L (mm)	97 x 100	40 x 100	200	160	145	190
M/ φ (mm)	M 20	M 20	M 16	M 18		
φ (mm)	φ 27	φ 14	φ 27	φ 30	φ 27	φ 35
W (kg)	0,750	0,500			0,500	1,100

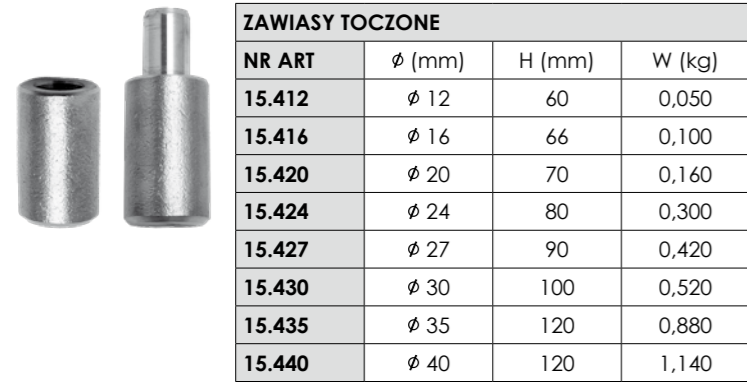

ZAWIASY TOCZONE			
NR ART	φ (mm)	H (mm)	W (kg)
15.412	φ 12	60	0,050
15.416	φ 16	66	0,100
15.420	φ 20	70	0,160
15.424	φ 24	80	0,300
15.427	φ 27	90	0,420
15.430	φ 30	100	0,520
15.435	φ 35	120	0,880
15.440	φ 40	120	1,140

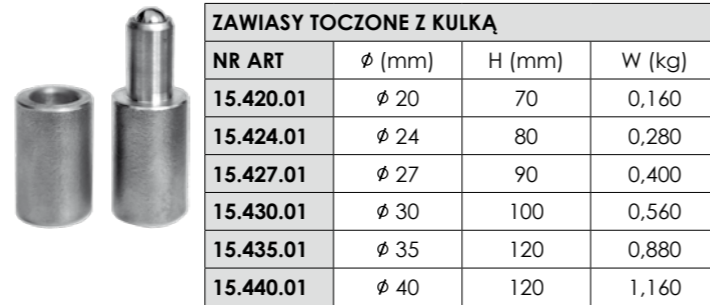

ZAWIASY TOCZONE Z KULKĄ			
NR ART	φ (mm)	H (mm)	W (kg)
15.420.01	φ 20	70	0,160
15.424.01	φ 24	80	0,280
15.427.01	φ 27	90	0,400
15.430.01	φ 30	100	0,560
15.435.01	φ 35	120	0,880
15.440.01	φ 40	120	1,160



NR ART	φ (mm)	L (mm)	□ (mm)
15.441	φ 14	400	□ 35 x 4
15.442	φ 14	600	□ 35 x 4
15.443	φ 18	800	□ 40 x 5
15.444	φ 18	1000	□ 50 x 5
15.445	φ 20	1200	□ 60 x 6



NR ART	15.451	15.451.01	15.451.05	15.451.06	15.451.07	15.451.08	15.451.09	15.453.01
H x L (mm)	400 x 650	250 x 290	400	150	200	220	270	200 x 50
□ (mm)	□ 50 x 5	□ 35 x 4	□ 50 x 5	□ 35 x 5	□ 40 x 6	□ 50 x 6	□ 60 x 8	□ 50 x 5
φ (mm)	φ 27	φ 14	φ 27	φ 14	φ 18	φ 18	φ 20	φ 27
W (kg)	2,750	0,510	1,680	0,240	0,440	0,580		0,800



NR ART	φ (mm)	L (mm)	□ (mm)
15.448	φ 14	500	□ 35 x 4
15.449	φ 18	700	□ 50 x 5

NR ART	15.452	15.452.01	15.452.05	15.452.06
H x L (mm)	400 x 650	250 x 290	400	150
□ (mm)	□ 50 x 5	□ 35 x 4	□ 50 x 5	□ 35 x 5
φ (mm)	φ 27	φ 14	φ 27	φ 14
W (kg)	2,750	0,520	1,600	0,200

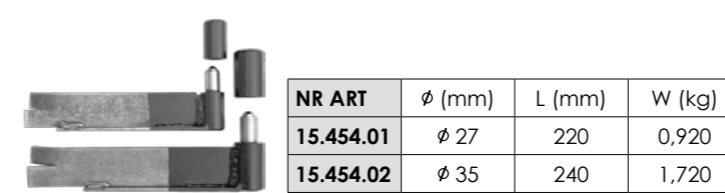

NR ART	φ (mm)	L (mm)	W (kg)
15.454.01	φ 27	220	0,920
15.454.02	φ 35	240	1,720

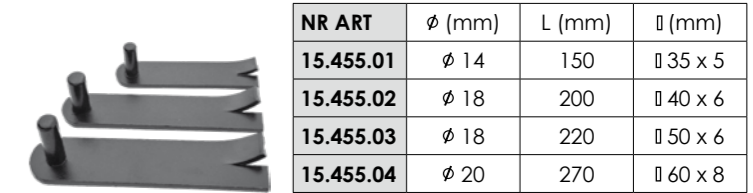

NR ART	φ (mm)	L (mm)	□ (mm)
15.455.01	φ 14	150	□ 35 x 5
15.455.02	φ 18	200	□ 40 x 6
15.455.03	φ 18	220	□ 50 x 6
15.455.04	φ 20	270	□ 60 x 8



RYGLE	MALOWANE			NIEMALOWANE			OCYNKOWANE					
	NR ART	15.462	15.463	15.464	15.462.01 WAŚKI	15.463.01	15.464.01 WAŚKI	15.462.02 WAŚKI	15.462.04 SPRĘŻYNA	15.464.02 WAŚKI	15.464.04 SPRĘŻYNA	15.468
L (mm)		220	320	420	220	320	420	220	220	420	420	800
φ (mm)		φ 12	φ 14	φ 14	φ 12	φ 14	φ 14	φ 12	φ 12	φ 14	φ 14	φ 14
W (kg)		0,370	0,620	0,820								1,250



ZASUWA	MALOWANE				NIEMALOWANE	OCYNKOWANE				
	NR ART	15.471	15.472	15.473		15.478	15.473.01	15.471.02	15.472.02	15.473.02
L (mm)		150	270	340	210	340	150	270	340	340
φ (mm)		φ 12	φ 16	φ 16	φ 14	φ 16	φ 12	φ 16	φ 16	φ 16
W (kg)		0,290	0,900	1,160		1,000	0,290	0,900	1,160	1,000



NR ART	15.530	15.533	15.533.01	15.533.02	15.534	15.534.01	15.534.02	15.634	15.634.01
□ (mm)		50 x 30	50 x 30	50 x 30	50 x 30	50 x 30	50 x 30	40 x 25	40 x 25
H (mm)		200	245	245	245	165	165	225	225
W (kg)		0,240	0,460	1,040	0,860	0,320	0,560	0,580	

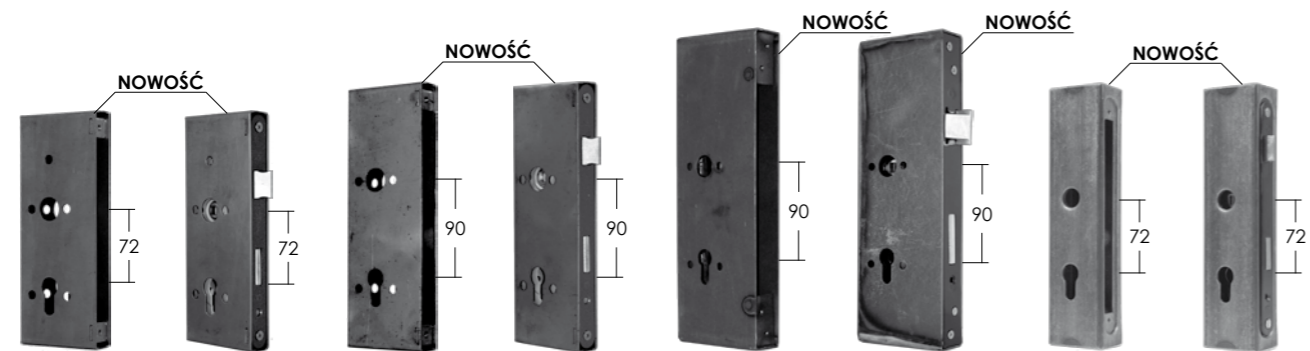

NR ART	15.638	15.638.01	15.639	15.639.01	15.640	15.640.01	15.641	15.641.01
□ (mm)	85 x 25	85 x 25	85 x 25	85 x 25	105 x 35	105 x 35	60 x 40	60 x 40
H (mm)	215	215	240	240	305	305	245	245
W (kg)							0,740	1,240

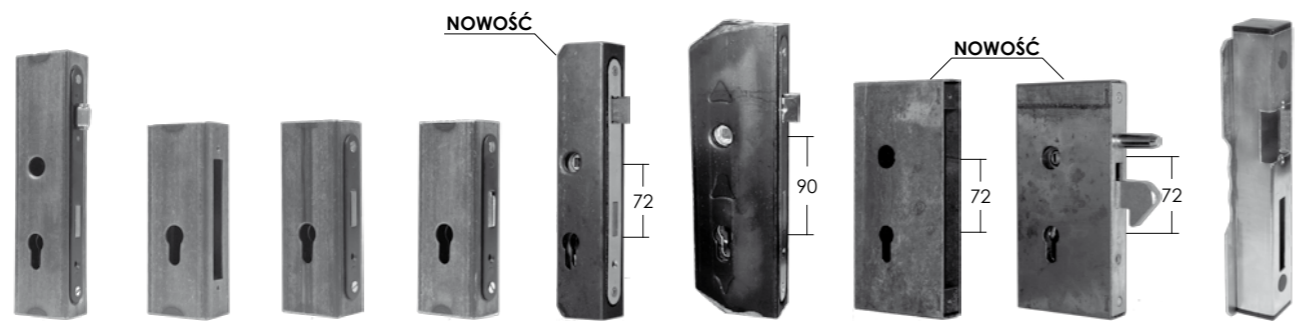

NR ART	15.641.02	15.642	15.642.01	15.642.02	15.645.01	15.648.01	15.649	15.649.01	15.650
□ (mm)	60 x 40	60 x 40	60 x 40	60 x 40	50 x 40	80 x 40	105 x 30	105 x 30	40 x 40
H (mm)	245	165	165	165	245	260	215	215	280
W (kg)	1,180	0,520	0,780	0,780		1,420			0,940

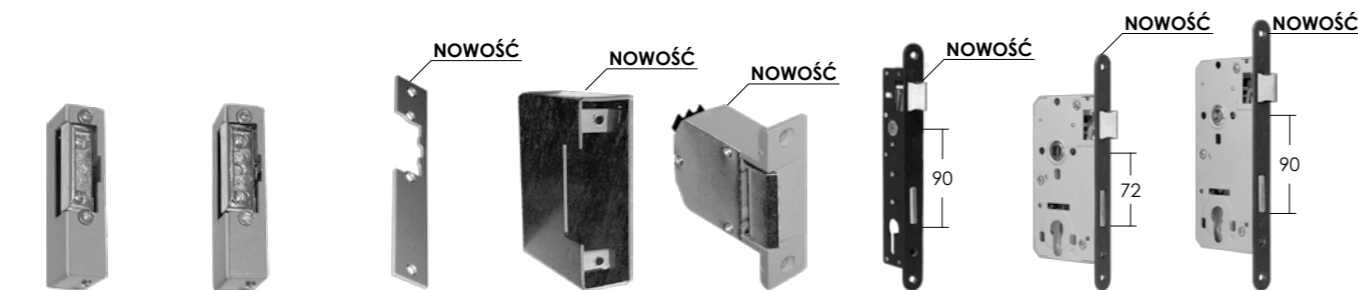

NR ART	15.651	15.651.01	15.651.05	15.652	15.652.01	15.664	15.668	15.669
	ELEKTROZACZEP	ELEKTROZACZEP Z BLOKADĄ	SZYLD UNIWERSALNY		ELEKTROZACZEP SZEROKI	ZAPADKOWO-ZASUWKOWY	ZAPADKOWO-ZASUWKOWY	ZAPADKOWO-ZASUWKOWY
H x L (mm)	90	90	147 x 27	102	95	220	210	235
W (kg)	0,940	0,940	0,070	0,240	0,240			



NR ART	15.670	15.671	15.672	15.673	15.674	15.675	15.677	15.679
	ZAMEK BRAMOWY	ZAPADKOWO-ZASUWKOWY	ROLKOWO-ZASUWKOWY	ZASUWKOWY	ZAMEK ROLKOWY	ZAMEK HAKOWY	ZAMEK HAKOWY H 40	ZAMEK HAKOWY H 60
H (mm)	300	220	220	140	100	140	250	210
W (kg)		0,600	0,540	0,300	0,200	0,300		

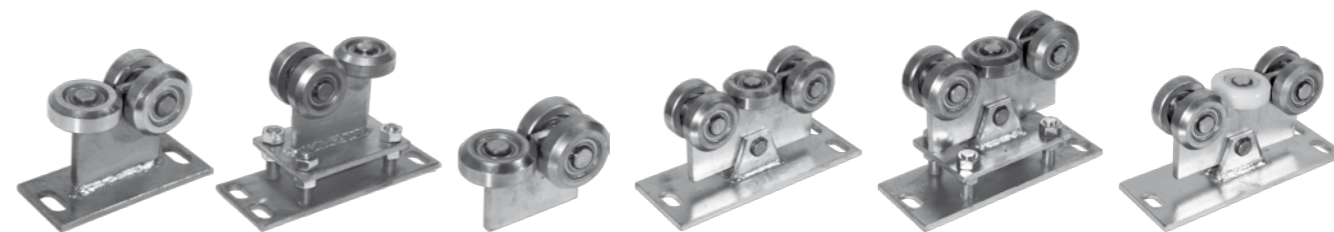

NR ART	15.703	15.703.02	15.705	15.705.01		
	WÓZEK JEZDNY 70	WÓZEK JEZDNY 70	WÓZEK JEZDNY 70	WÓZEK JEZDNY 70		
W (kg)	2,500	1,520	4,640	6,040		
NR ART	15.803	18.803.01	15.803.02	15.805	15.805.01	15.805.02
	WÓZEK JEZDNY 80	WÓZEK JEZDNY 80	WÓZEK JEZDNY 80	WÓZEK JEZDNY 80	WÓZEK JEZDNY 80	WÓZEK JEZDNY 80
W (kg)	2,940	4,920	0,820	5,260	6,680	5,000

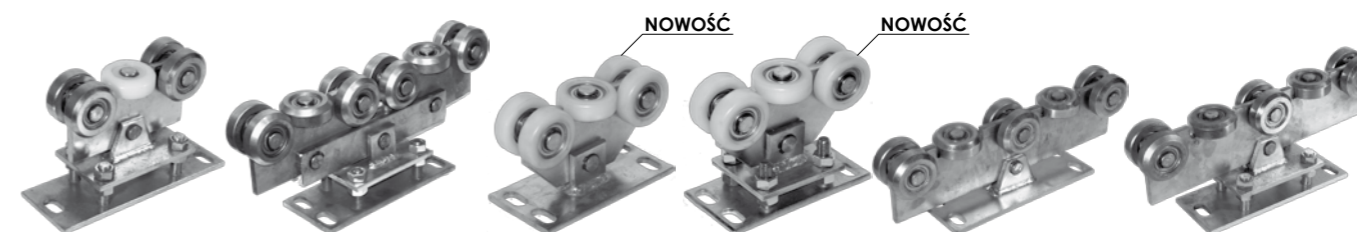

NR ART	15.805.03	15.805.04	15.805.06	15.805.07	15.808	15.808.01
	WÓZEK JEZDNY 80	WÓZEK JEZDNY 80	WÓZEK JEZDNY 80	WÓZEK JEZDNY 80	WÓZEK JEZDNY 80	WÓZEK JEZDNY 80
W (kg)	6,300	12,500			8,220	9,560

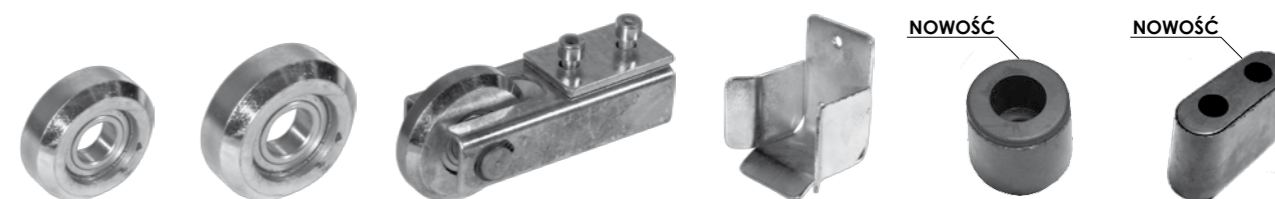

NR ART	15.820	15.821	15.825	15.826	15.828	15.829
	ROLKA STAŁOWA	ROLKA STAŁOWA	ROLKA NAJAZDOWA	UCHWYT NAJAZDU	ODBOJNIK GUMOWY	ODBOJNIK GUMOWY
H x L (mm)	∅ 60	∅ 68			∅ 60	∅ 68
W (kg)	0,260	0,380	0,820	0,820	0,260	0,380



NR ART	15.830	15.830.01	15.830.02	15.831	15.831.01	15.832	15.832.01
	ODBÓJ	ODBÓJ	ODBÓJ	ROLKA "T"	ROLKA "T"	ROLKA "V"	ROLKA "V"
H x L (mm)	35 x 155	55 x 155	80 x 155	∅ 70 x 20	∅ 88 x 25	∅ 70 x 23	∅ 88 x 25
W (kg)	1,940	2,380	3,200	0,420	0,800	0,420	0,800



NR ART	15.836	15.833	15.833.01	15.833.02	15.833.05	15.834	15.835	15.840
	ROLKA "U"	ROLKA	ROLKA	ROLKA	ROLKA	PROWADZENIE GÓRNE	PROWADZENIE GÓRNE	ROLKA
∅ / H (mm)	∅ 88 x 25	∅ 33	∅ 25	∅ 42	∅ 40	50 x 90	50 x 190	∅ 33 X 90
W (kg)	0,800	0,080	0,070	0,100		0,780	1,580	



NOWOŚĆ

ZESTAWY DO BRAM PRZESUWNYCH			ZESTAWY DO BRAM GARAŻOWYCH	
BX EURO do bramy o masie do 300 kg	BX PLUS do bramy o masie do 400 kg	BX STRONG do bramy o masie do 800 kg	VER - 700 Siła ciągu 850 N	VER - 900 Siła ciągu 550 N
- siłownik BX-243 - centrala sterująca ZN2 - karta częstotliwości AF 43S - pilot TAM-432SA	- siłownik BX-74 - karta częstotliwości AF 43S - fotokomórka DIR 10 - pilot TAM-432SA	- siłownik BX-78 - karta częstotliwości AF 43S - fotokomórka DIR 10 - pilot TAM-432SA	- siłownik V-700E - karta częstotliwości AF 43S - pilot TAM-432SA	- siłownik V-900E - karta częstotliwości AF43S - pilot TAM-432SA

Istnieje możliwość wymiany sterowania radiowego **TAM** na sterowanie radiowe **TOP** lub **SPACE** przy zachowaniu jednakowej ceny zakupu



NOWOŚĆ

ZESTAWY DO BRAM SKRZYDŁOWYCH			
AMICO EURO o dł. skrzydła do 2200 mm	FAST PLUS o dł. skrzydła do 2300 mm	KRONO STANDARD o dł. skrzydła do 3000 mm	KRONO PLUS o dł. skrzydła do 3000 mm
- siłowniki A18230 - karta częstotliwości AF 43S - centrala sterująca ZF 1N - fotokomórka DIR 10 - pilot TAM-432SA	- siłowniki F 7000 i F 7001 - karta częstotliwości AF 43S - fotokomórka DIR 10 - pilot TAM-432SA	- siłowniki KR 300D i KR 300S - karta częstotliwości AF 43S - płyta sterująca ZF 1N - fotokomórka DIR 10 - pilot TAM-432SA	- siłowniki KR 310D i KR 310S - karta częstotliwości AF 43S - centrala sterująca ZA 3N - fotokomórka DIR 10 - pilot TAM-432SA Siłowniki zawierają wbudowane wyciągniki krańcowe

Istnieje możliwość wymiany sterowania radiowego **TAM** na sterowanie radiowe **TOP** lub **SPACE** przy zachowaniu jednakowej ceny zakupu



NR ART	15.850	C8	CGZF	SZYNA Z ŁAŃCUCHEM DO BRAM GARAŻOWYCH		
φ / H (mm)	φ 80	1000	1000 (3 x 330)	NR ART	uchyłnych do wys.	segmentowych do wys.
G/ l (mm)	18 trybów	l 8		V0679	2400 mm	2250 mm
W (kg)	0,900	1,640	3 x 0,550	V0682	2900 mm	2750 mm
NR ART	15.850.01	C10		V0683	3400 mm	3250 mm
φ / H (mm)	φ 68	1000				
G/ l (mm)	15 trybów	l 10				
W (kg)	0,900	2,060				



TAM 432 SA	TOP 432 NA	TOP 434 NA	SP 2	SP 4	TOP A433N	KIARO N
KOD STAŁY	KOD STAŁY	KOD STAŁY	KOD ZMIENNY	KOD ZMIENNY	433 MHz	230V/25W



NR ART	16.010	16.010.01	16.015.01	16.085.01
H x L (mm)	75 x 145	75 x 145	75 x 145	75 x 145
W (kg)	0,550	0,540	0,460	0,620



NR ART	16.306.04	16.306.05	16.306.06	16.306.07	16.306.18	16.306.19
H x L (mm)	90	65	65	70	40 x 110	45 x 85
φ (mm)	φ 65	φ 65	φ 70	φ 68	φ 68	φ 68
W (kg)	0,480	0,420	0,420	0,440	0,420	0,280



NR ART	16.306.01	16.306.02	16.306.08	16.306.11	16.306.12	16.306.13
H x L (mm)	50 x 155	50 x 125	50 x 130	50 x 170	50 x 130	50 x 110
W (kg)	0,900	0,800	0,660	0,900	0,740	0,760

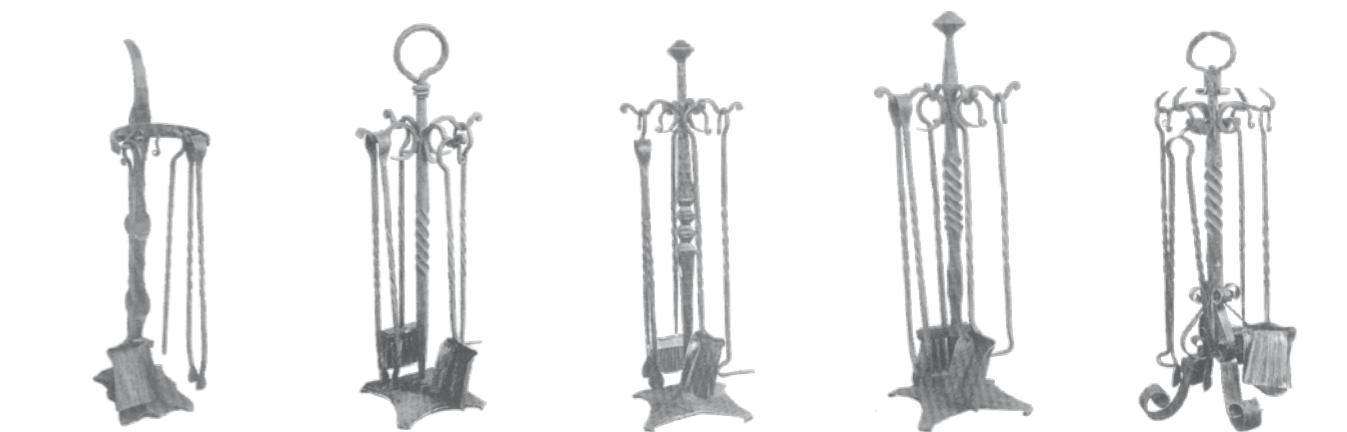

NR ART	16.410.01	16.410.02	16.410.03	16.410.04	16.410.05
H (mm)	700	700	820	700	880
W (kg)	6,000	5,300	9,110	5,800	11,100



NR ART	16.410.06	16.410.07	16.410.08	16.410.09	16.410.10
H x L (mm)	340 x 405	390 x 385	410 x 430	385 x 390	465 x 435
W (kg)	2,600	2,530	4,600	3,000	2,600

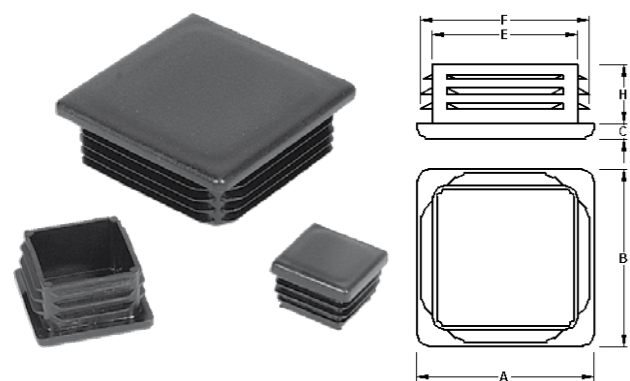

NR ART	□ A x B (mm)	C (mm)	H (mm)	E (mm)	F (mm)
17.015	□ 15 x 15	5,0	11,5	10,8	14,5
17.016	□ 16 x 16	5,0	11,0	10,8	14,8
17.020	□ 20 x 20	5,0	14,0	12,9	18,6
17.025	□ 25 x 25	5,0	15,0	18,0	23,2
17.030	□ 30 x 30	5,0	15,0	23,0	28,2
17.035	□ 35 x 35	5,0	15,0	27,4	33,7
17.040	□ 40 x 40	5,0	18,0	33,1	38,4
17.050	□ 50 x 50	5,0	18,0	43,7	48,0
17.060	□ 60 x 60	5,0	18,0	53,0	58,3
17.070	□ 70 x 70	5,0	18,5	60,8	67,3
17.080	□ 80 x 80	5,0	22,0	66,8	77,4
17.100	□ 100 x 100	5,0	23,0	86,0	96,0
17.120	□ 120 x 120	5,0	25,0	109,0	116,0

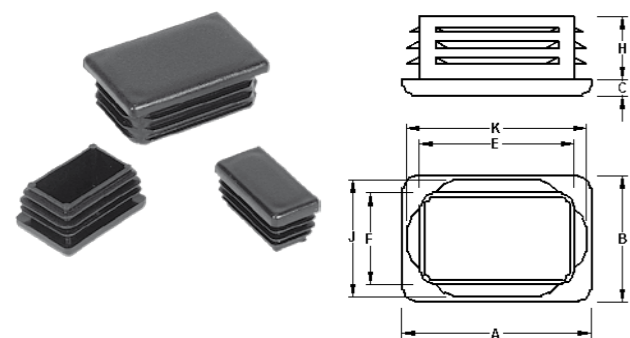

NR ART	▭ A x B (mm)	C (mm)	H (mm)	▭ E x F (mm)	▭ K x J (mm)
17.210.20	▭ 20 x 10	5,0	11,5	▭ 16,5 x 6,4	▭ 18,5 x 8,7
17.215.25	▭ 25 x 15	5,0	11,5	▭ 19,6 x 10,4	▭ 23,9 x 14,3
17.218.30	▭ 18 x 30	5,0	14,0	▭ 21,6 x 11,0	▭ 28,5 x 16,5
17.220.30	▭ 30 x 20	5,0	14,0	▭ 22,5 x 13,0	▭ 28,5 x 18,5
17.220.40	▭ 40 x 20	5,0	14,0	▭ 32,6 x 13,0	▭ 38,5 x 18,5
17.225.40	▭ 40 x 25	5,0	12,0	▭ 35,3 x 19,3	▭ 39,1 x 23,1
17.227.40	▭ 40 x 27	5,0	12,0	▭ 32,6 x 19,8	▭ 38,2 x 25,4
17.230.50	▭ 50 x 30	5,0	15,0	▭ 42,5 x 22,8	▭ 47,5 x 27,6
17.230.60	▭ 60 x 30	5,0	14,0	▭ 53,8 x 23,6	▭ 57,5 x 27,5
17.240.60	▭ 60 x 40	5,0	17,5	▭ 53,0 x 32,8	▭ 58,0 x 38,2
17.240.80	▭ 80 x 40	5,0	17,0	▭ 68,5 x 32,6	▭ 76,2 x 38,6
17.250.100	▭ 100 x 50	5,0	24,5	▭ 92,4 x 42,1	▭ 96,5 x 46,4

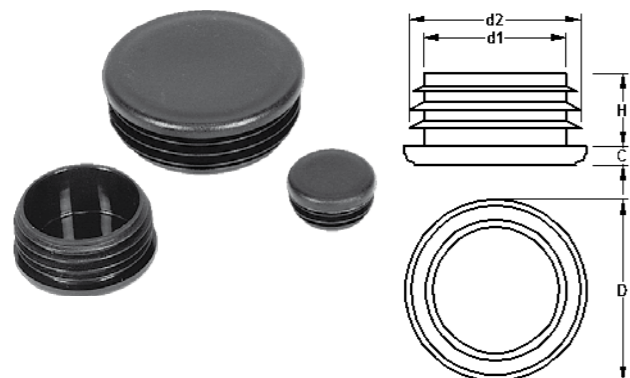

NR ART	∅ D (mm)	C (mm)	H (mm)	∅ d1 (mm)	∅ d2 (mm)
17.303	∅ 42,4 (1 1/4")	5,0	15,0	∅ 32,3	∅ 36,5
17.304	∅ 48,3 (1 1/2")	5,0	17,5	∅ 38,2	∅ 42,4
17.305	∅ 60,3 (2")	5,0	18,0	∅ 49,3	∅ 53,6
17.306	∅ 76,1 (2 1/2")	5,0	22,0	∅ 63,5	∅ 71,3
17.316	∅ 16	5,0	10,0	∅ 10,0	∅ 14,1
17.318	∅ 18	5,0	12,0	∅ 13,3	∅ 16,8
17.320	∅ 20	5,0	12,0	∅ 15,1	∅ 19,0
17.325	∅ 25	5,0	12,0	∅ 17,9	∅ 23,4
17.330	∅ 30	5,0	14,5	∅ 26,0	∅ 30,3
17.332	∅ 32	5,0	14,5	∅ 26,0	∅ 30,3
17.335	∅ 35	5,0	14,0	∅ 28,9	∅ 34,0
17.340	∅ 40	5,0	15,0	∅ 33,0	∅ 38,3
17.343	∅ 43	5,0	15,0	∅ 34,0	∅ 40,8
17.350	∅ 50	5,0	17,5	∅ 42,3	∅ 48,8
17.360	∅ 60	5,0	18,8	∅ 48,6	∅ 57,6
17.370	∅ 70	5,0	22,0	∅ 58,0	∅ 67,0
17.376	∅ 76	5,0	22,0	∅ 62,8	∅ 73,8
17.376.01	∅ 76	5,0	22,0	∅ 62,8	∅ 71,3



NR ART	∅ D (mm)	ŚRUBA/KLUCZ	H (mm)	B (mm)	A (mm)
17.386	∅ 13,2	M 6 - 10	13,4	9,9	7,3
17.388	∅ 17,6	M 8 - 13	16,5	12,9	8,7
17.390	∅ 21,6	M 10 - 17	20,3	16,9	10,1
17.392	∅ 23,6	M 12 - 19	21,9	18,9	11,4
17.394	∅ 27,4	M 14 - 22	27,4	21,9	12,5
17.396	∅ 29,6	M 16 - 24	29,6	23,9	14,0



NR ART	∅ D (mm)	R (mm)	C (mm)	H (mm)	∅ d1 (mm)	∅ d2 (mm)
17.420	∅ 20	1 - 2	5	11,8	∅ 15,5	∅ 19
17.425	∅ 25	1 - 2	5	12,0	∅ 18,8	∅ 24
17.428	∅ 28	1 - 2	5	14,0	∅ 21,2	∅ 27
17.432	∅ 32	1 - 2	5	14,6	∅ 26,3	∅ 30,2

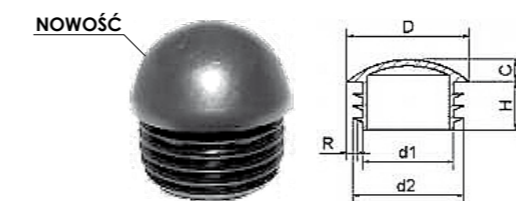

NR ART	∅ D (mm)	R (mm)	C (mm)	H (mm)	∅ d1 (mm)	∅ d2 (mm)
17.520	∅ 20	1,5 - 2,5	10,0	15,5	∅ 12,0	∅ 18,3
17.542	∅ 42,4 (1 1/4")	1,5 - 2,5	21,2	25,0	∅ 36,5	∅ 32,3
17.548	∅ 48,3 (1 1/2")	1,5 - 2,5	24,1	25,0	∅ 38,2	∅ 42,4
17.550	∅ 49,8	1,5 - 2,5	25,5	29,5	∅ 39,0	∅ 47,2
17.560	∅ 60,3	1,5 - 2,5	30,1	25,0	∅ 49,3	∅ 53,6

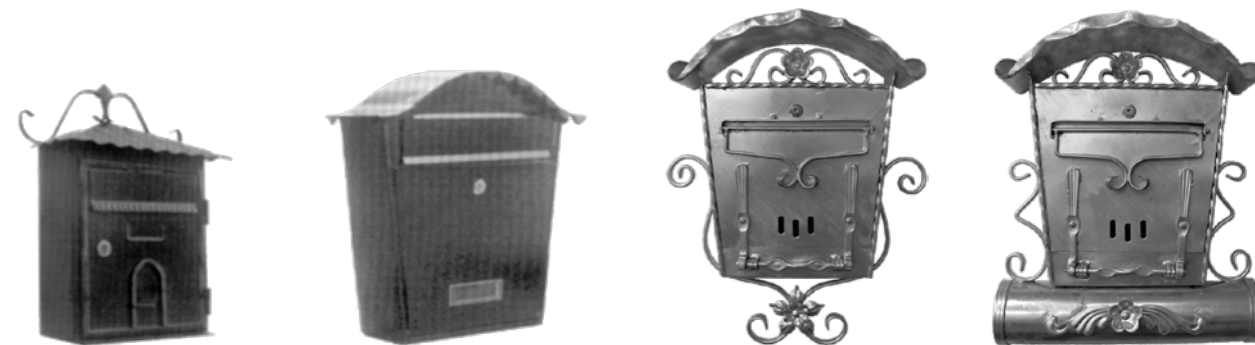

NR ART	16.030.01	16.030.02	17.400	17.401
H x L (mm)	350 x 280	370 x 360	545 x 450	510 x 410
G (mm)	200	130		
W (kg)	1,380	2,000	6,000	6,700



NR ART	KOLOR	H x L (mm)	G (mm)	W (kg)
16.034	czerwony	410 x 255	90	1,860
16.035	brązowy	410 x 255	90	1,860
16.036	szary	410 x 255	90	1,860
16.037	zielony	410 x 255	90	1,860
16.038	grafit	410 x 255	90	1,860
16.039	czarny	410 x 255	90	1,860
16.040	czerwony	470 x 298	95	2,300
16.041	brązowy	470 x 298	95	2,300
16.042	szary	470 x 298	95	2,300
16.043	zielony	470 x 298	95	2,300
16.044	grafit	470 x 298	95	2,300
16.045	czarny	470 x 298	95	2,300



NR ART	17.901.01	17.901.02	17.902.01
H x L (mm)	400	670	790

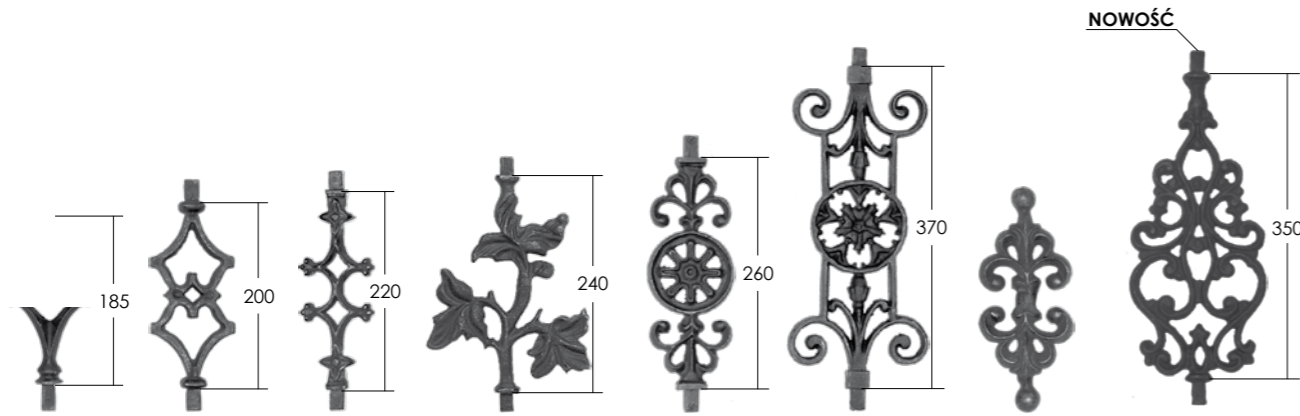

NR ART	17.701	17.703	17.704	17.705	17.706	17.707	17.708	17.709
H x L (mm)	240 x 100	245 x 90	260 x 82	280 x 180	310 x 95	400 x 155	250 x 100	390 x 145
□ (mm)	□ 15 x 15	□ 15 x 15	□ 15 x 15	□ 15 x 15	□ 15 x 15	□ 15 x 15		□ 15 x 15
W (kg)	0,760	0,480	0,660	0,480	0,300	0,260	0,110	



NR ART	17.713	17.714	17.715	17.727	17.728
H x L (mm)	270 x 235	160 x 150	250 x 140	230 x 110	100 x 490
□ (mm)	□ 20	□ 20	□ 20		□ 14 x 14
W (kg)	2,560	0,900	1,500		

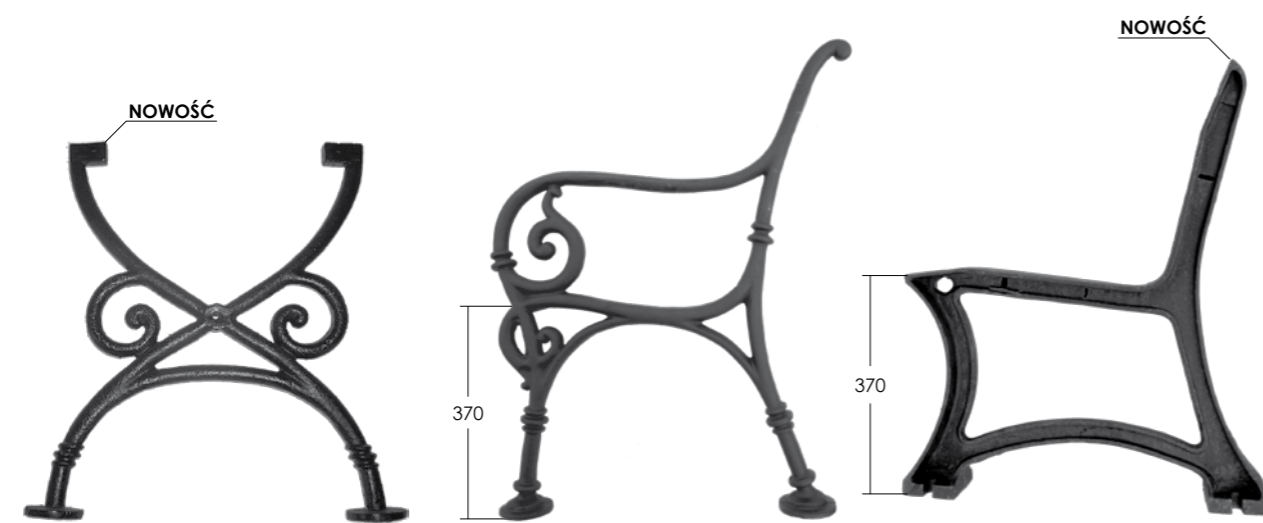

NR ART	17.731	17.733	17.743
H x L (mm)	630 x 520	780 x 580	690
W (kg)	15,000	17,200	17,200



NR ART	16.081	16.081.01	16.082	16.082.01	16.084	16.084.01
	farba GRAFIT	farba GRAFIT	farba CZARNY MAT	farba CZARNY MAT	farba BRAŻ	farba BRAŻ
Poj. (L)	0,8 L	3 L	0,8 L	3 L	0,8 L	3 L
W (kg)	1,200	4,200	1,200	4,200	1,200	4,200



NR ART	16.090	16.091	16.092	16.093	16.094
	patyna ŻŁOTO	patyna MIEDŹ	patyna SREBRO	patyna CIEMNA ZIELEŃ	patyna TURKUS
Poj. (L)	0,22 L	0,22 L	0,22 L	0,22 L	0,22 L
W (kg)	0,280	0,280	0,280	0,280	0,280



NR ART	16.095	16.096	16.097	16.098	16.099
	patyna BŁĘKIT	patyna ŻÓŁTA	patyna CZERWIĘŃ	patyna BIAŁA	patyna ZIELEŃ
Poj. (L)	0,22 L	0,22 L	0,22 L	0,22 L	0,22 L
W (kg)	0,280	0,280	0,280	0,280	0,280



NR ART	17.900	17.903	17.907	17.908
H x L (mm)	1420 x 650 x 460	1300 x 600 x 460	1190 x 600 x 550	1270 x 830 x 670
W (kg)	6,700	6,000	6,000	7,240

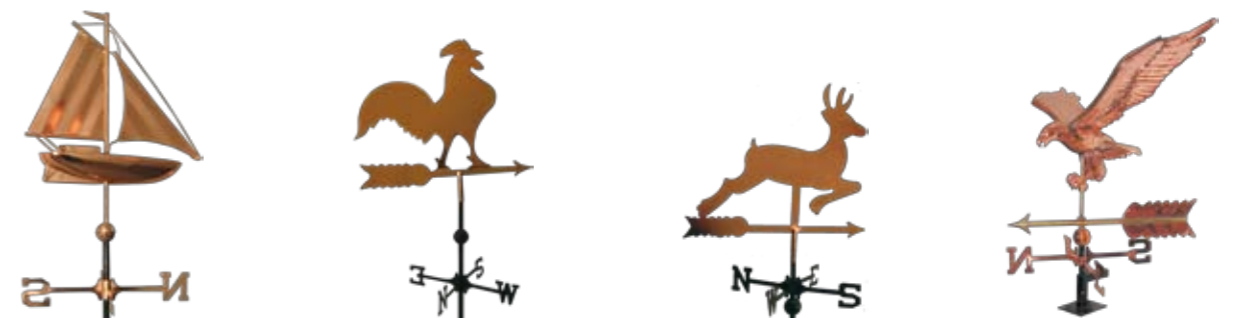

NR ART	17.909	17.913	17.914	17.921
H x L (mm)	1340 x 510 x 460	810 x 350	810 x 330	1180 x 610
W (kg)	5,720	1,860	1,660	7,700

stalowe elementy kute

stalowe elementy kute

POLSWAT

Centrala:

26-600 Radom, ul. 1905-go Roku 3L
tel. 48 366 52 89, 385 13 77, 385 13 78
fax. 48 366 49 72

Oddziały:

02-495 Warszawa, ul. Ryżowa 60
tel. 22 667 77 79, fax. 22 662 78 92

64-520 Obrzycko, Stópanowo - Huby 10B
tel. 61 292 32 57, fax. 61 292 13 20

20-469 Lublin, ul. Budowlana 11
tel. 81 441 74 51, fax. 81 441 83 51

www.polswat.pl
e-mail: polswat@polswat.com.pl